

XL2

OPERATING MANUAL
HANDHELD AUDIO AND
ACOUSTIC ANALYZER

Contact Details

NTi Audio AG
Im alten Riet 102
9494 Schaan
Liechtenstein, Europe

Tel.: +423 239 6060
Fax: +423 239 6089
E-Mail: info@nti-audio.com
Web: www.nti-audio.com

NTI Americas
PO Box 231027
Tigard, Oregon 97281
USA

Tel.: +1 503 684 7050
Fax: +1 503 684 7051
E-Mail: americas@nti-audio.com

NTI China
Room 722, 7F, Building 6-3A,
No 1388, Bin He Rd.
215000 Suzhou, China

Tel.: +86 512 6802 0075
Fax: +86 512 6802 0097
E-Mail: china@nti-audio.com

NTI Japan
Ryogokusakamoto Bld. 1-8-4
Ryogoku, 130-0026 Sumida-Ku
Tokyo, Japan

Tel.: +81 3 3634 6110
Fax: +81 3 3634 6160
E-Mail: japan@nti-audio.com



NTi Audio is an ISO 9001:2008
certified company.

Firmware V2.31
Version 2.31.00 / Dec. 2011

All information subject to change without notice.

- © All rights reserved.
- ® Minirator is a registered trademark of NTi Audio.
- ™ XL2, EXEL, M4260, M2210, MA220, MR-PRO, MR2 and TalkBox are trademarks of NTi Audio.

Made in
Switzerland 

Table of Contents

1. Introduction	5	5. Acoustic Analyzer	62
2. Overview	7	FFT Analysis + Tolerance	62
Operation	9	Reverberation Time RT60	72
The Screen Display	11	Polarity	84
3. Getting Started	14	Delay Time	88
Power Supply	14	1/12 Octave + Tolerance (optional)	94
Attaching the Hand Strap	17	Speech Intelligibility STI-PA (optional)	104
Unfolding the Stand	18	6. Audio Analyzer	113
Connecting the XL2	18	RMS / THD+N	113
Switching the XL2 On and Off	20	Oscilloscope	115
Select Measurement Function	20	7. Calibration	116
4. Sound Level Meter	22	8. Profiles	119
Overview	25	9. Spectral Limits Option (Capture + Tolerances)	126
Sound Level Meter - Getting Started	33	10. System Settings	137
RTA Measurement - Getting Started	39	11. Scheduler	141
Correction Value KSET	44	12. Data Management	144
Logging	49	Record Voice Notes	149
Wav-File Recording	51	Recall Measurements	155
Events (optional)	53	Append Measurements	157
Limits	60		









13. XL2 Projector.....	161
14. Noise Monitoring Network.....	163
15. Remote Measurement.....	163
16. Microphones	164
17. Further Information	167
Registration.....	167
Tips and Troubleshooting	168
Firmware Update	170
Options and Accessories	171
Warranty Conditions	177
Calibration Certificate.....	177
Declaration of Conformity.....	178
18. Technical Data XL2.....	179
19. Technical Data Microphones	184
Appendix	187
Appendix 1: Standard - Optional Features	187
Appendix 2: Factory Default Profiles	190
Appendix 3: Description Sound Levels	195
Appendix 4: Common Sound Levels.....	199

1. Introduction

Thank you for purchasing the XL2 Audio and Acoustic Analyzer. The XL2 Analyzer forms the unique combination of a state-of-the-art Sound Level Meter, a comprehensive Acoustic Analyzer as well as a powerful Audio Analyzer. The wide range of functionalities is tailored for:

- Live Sound
- Installed Sound
- Environmental Noise
- PA Hire
- Broadcast
- AVI-Installation
- Cinemas
- Building Acoustics
- Occupational Health
- Quality Control
- Vehicle Noise Inspection
- R&D and Service
- Education and Training

How to Read this Manual

The XL2 push buttons are displayed as icons , , , , , , , , . A detailed description of the push buttons is listed in the chapter “Overview - Operation”.

Menu items displayed on the XL2 page screens are shown in this user manual by a bold font, e.g., **SLMeter**, **Parameter**, ...

Product Configurations

The following items are included with the respective model:

- XL2 + M4260:
- XL2 Analyzer
 - M4260 Microphone with pouch
 - Wind protection
 - Microphone holder + Adapter 5/8" - 3/8"
 - Test Signal CD
 - Li-Po battery
 - USB cable
 - Hand strap
 - Operating manual

- XL2 + M2210:
- XL2 Analyzer
 - M2210 Microphone with pouch
 - Wind protection
 - Microphone holder + Adapter 5/8" - 3/8"
 - Test Signal CD
 - Li-Po battery
 - USB cable
 - Hand strap
 - Operating manual

- XL2 without
Microphone:
- XL2 Analyzer
 - Test Signal CD
 - USB cable
 - Li-Po battery
 - Hand strap
 - Operating manual

2. Overview

XL2 interfaces:

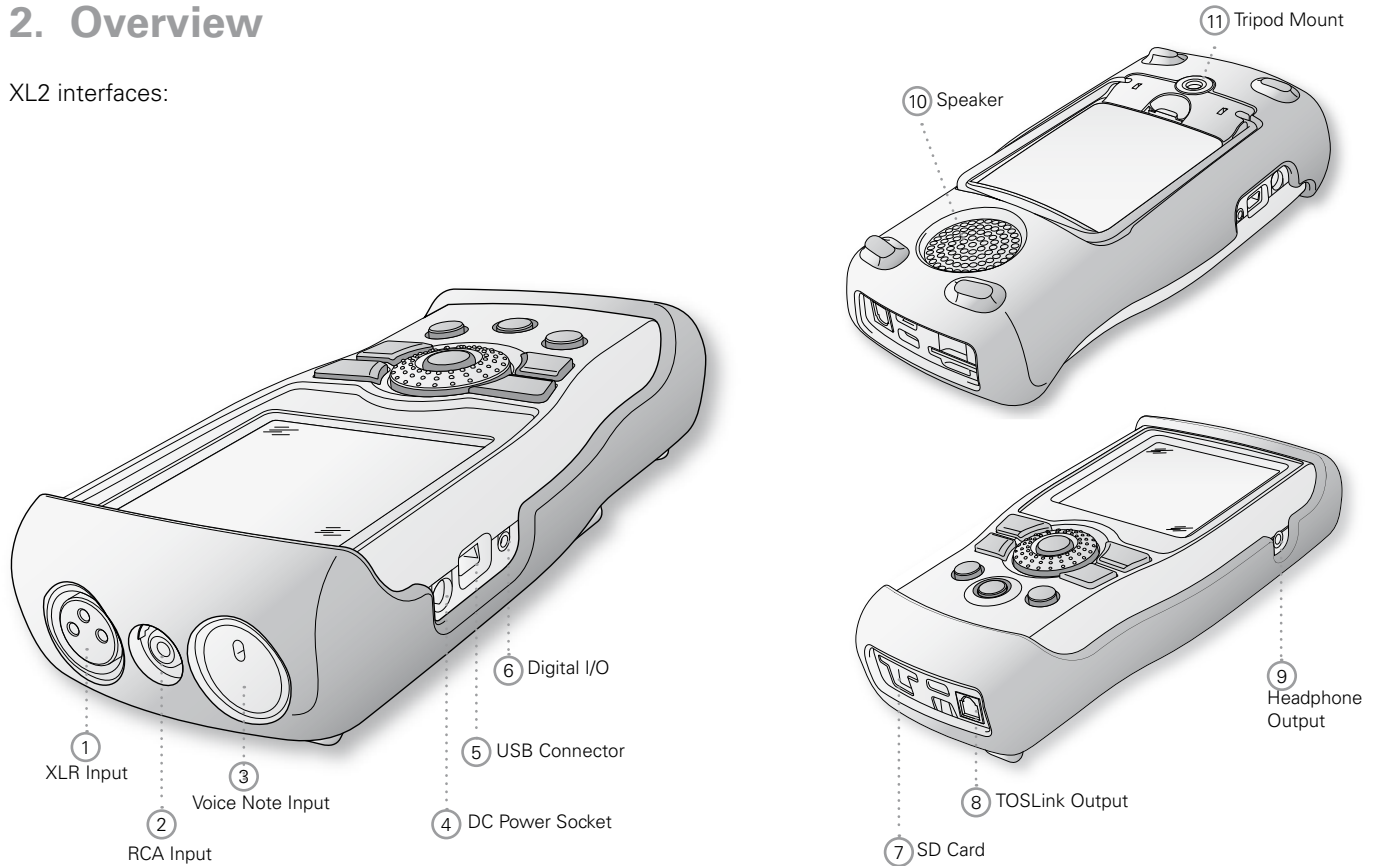

① XLR Signal Input

Either a balanced audio signal, an NTi Audio measurement microphone or the microphone pre-amplifier MA220 plug directly into the XLR input. The Automated Sensor Detection (ASD) technology reads the electronic data sheet of any connected NTi Audio device after the 48 V microphone phantom power is activated.

② RCA Input

Unbalanced audio signal input.

③ Voice Note Input

Internal microphone for recording voice notes and measuring polarity and delay time. For polarity measurements, an external microphone may also be used.

④ DC Power Socket

Socket for mains power adapter. Further details in the chapter “Power Supply” in this manual.

⑤ USB Connector

Mini-B USB connection, for accessing the SD Card.

⑥ Digital I/O

Programmable digital inputs/outputs.

⑦ SD Card

For storing data, screenshots, voice notes, wav-files.



⑧ TOSLink Output

24 bit linear PCM audio signal output. For future use; not active at this time.

⑨ Headphone Output

The XLR/RCA input signals are routed to the headphone output. Connecting headphones mutes the internal speaker. To connect the headphone output directly to a line input, a load impedance < 8 kOhm is required for proper operation. This can be achieved by inserting a 1 kOhm resistance between tip and ground of the output jack.

⑩ Speaker

The XLR/RCA input signals are routed to the speaker. Press the speaker button  to toggle the speaker on/off. Press and hold the speaker button to access the volume control. Set the speaker level with the rotary wheel .

⑪ Tripod Mount

Mechanical mount for attaching the XL2 to a tripod or microphone stand.

Operation

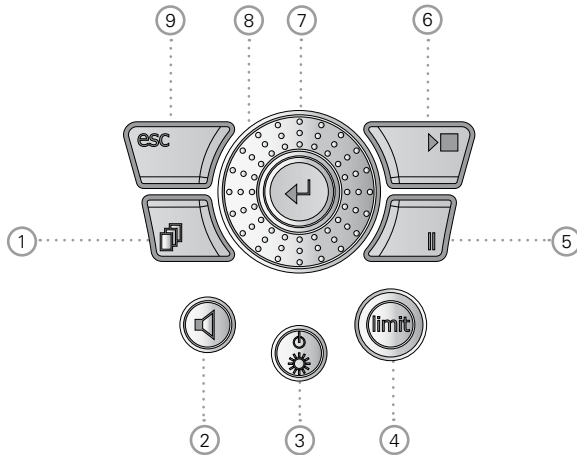

① Page Control

Switches amongst various screens depending on the menu function selected.

② Volume of Speaker and Headphone Output



- Press the button briefly to enable or disable the speaker.

The speaker is activated and the speaker or headphone icon shows up in the upper menu bar.

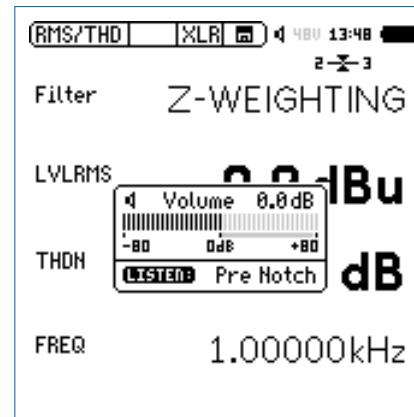

- Press and hold the speaker button .

A pop-up window for volume is displayed.



- Hold the speaker button  down and adjust the level of the speaker and headphone outputs with the rotary wheel . Digital gain control prevents gain increases beyond a level that will cause signal clipping. The maximum gain setting depends on the connected input signal.



3 Power & Backlight

The power button  switches the instrument on. The XL2 is immediately ready for operation. Holding down the power button  for one second switches the XL2 off. Additionally, a brief press of the power button  toggles the backlight during operation.

4 Limit

- **SLMeter:** The limit button lights up green, yellow or red according to the settings in the **Limit** page. Press the limit button  to access the **Limit** page. For more details visit the chapter “Limit Setting”.
- **FFT + Tol:** The limit button lights up green for results within tolerance and red for out-of-tolerance results.
- **Polarity:** The limit button lights up green at positive polarity and red at negative polarity.
- **1/12 Oct +Tol:** The limit button lights up green for results within tolerance and red for out of tolerance results.

5 Pause

Pauses the current measurement. Press the pause button  or the start/stop button  to continue the measurement.

6 Start/Stop

Starts and stops a measurement.

7 Enter

Confirms a selection.

8 Rotary Wheel

Selects the required measurement function or the individual measurement parameter.

9 ESC

Terminates an entry, returns to the top menu level or closes an open window.

The Screen Display

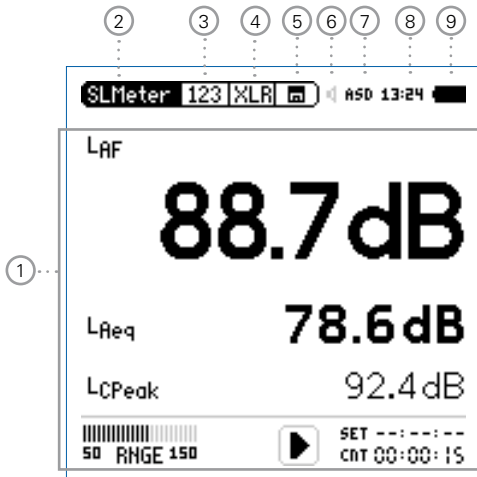

The display is updated continuously during measurement.

① Measurement Results

Individual measurement results display according to the selected measurement function.

② Main Menu

- SLMeter/RTA** SPL & RTA Measurement
- FFT + Tol** FFT Analysis with optional Tolerance Management
- RT60** Reverberation Time RT60
- Polarity** Polarity
- Delay Time** Delay Time
- RMS/THD+N** RMS Level and Distortion
- Oscilloscope** Scope
- 1/12 Oct + Tol** Spectral Analysis with Tolerance Management (optional)
- STI-PA** Speech Intelligibility (optional)
- Calibrate** Calibration Menu for microphone sensitivity
- Profile ...** Store and load measurement profiles
- System** System Settings

③ Page Selector

Toggles between available measurement and result pages within the same function menu. Alternatively use the page button .

④ Input Selector

Select XLR or RCA input connectors as the source.

⑤ Memory Menu

The memory menu is used for data storage management. One of the following symbols flashes before or after starting the measurement:

9-8-7 Time in seconds until instrument is settled and measurement will start.

RUN Indicates the ongoing measurement.

LOG Indicates the ongoing measurement with data logging.

AUD Indicates the ongoing measurement with data logging and audio recording.

Evt Indicates an ongoing triggered-event recording.

After a completed measurement, the memory symbol  indicates a non-saved measurement report. Your measurement needs to be stored manually. For more details visit the chapter “Data Management”.

⑥ Speaker/Headphone

Indication of enabled rear speaker or headphone output.

⑦ Phantom Power

The XL2 generates 48 VDC phantom power, which may be activated or deactivated here. An activated phantom power is displayed as **48V**. After connecting one of NTi Audio’s measurement microphones with electronic data sheet the Automated Sensor Detection (ASD) reads the data sheet from the microphone and the display changes from **48V** to **ASD**.

⑧ Real-Time Clock

The real-time clock is set in the **System** menu.

9 Battery Symbol

The battery symbol indicates the battery status as follows:

Using rechargeable Li-Po battery:



The battery is full.



Battery power level indication.



The battery is almost empty and must be recharged.



The battery is being recharged by the mains power adapter or the USB connection to PC.

Using standard AA batteries:

No indication of battery status, except...



the batteries are almost empty and should be replaced.

Using mains power supply:

No indication of battery status.

3. Getting Started

Power Supply

The XL2 offers flexible power management options and can be operated either by

- Mains power supply or
- Replaceable, rechargeable lithium-polymer (Li-Po) battery or
- 4x AA-batteries

The Li-Po battery is included with the XL2 Analyzer. The new battery is charged to approximately 50% and should be fully charged before use with:

Battery Charger (optional) Charging Time: approx. 3 hours
NTi Audio #: 600 000 332

Mains Power Adapter (optional) Charging Time: approx. 6 hours
Leave the battery inside and switch off the XL2  for charging.
NTi Audio #: 600 000 333

USB Power from PC Charging Time: approx. 6 hours
XL2 switches to the mass storage device mode for download of data. Switch off the XL2  for faster charging.

Operation using Mains Power Supply

You can also operate the XL2 with mains power using the NTi Audio DC power supply unit. During operation with this external Mains Power Adapter, it is recommended to leave the batteries inside the instrument.



Mains Power Adapter

- Electrically-isolated, linear DC power supply
- Non-NTi Audio power supplies may have negative effects on measurements.
- A decreased THD+N performance will occur with unbalanced input signals when using switching-type power supplies (approx. 3 dB).
- Damage caused by using an inappropriate external DC supply is not covered by warranty.



DC Power supply specifications

- Voltage: 7.5 - 23.0 Volt
- Power: minimum 6 Watt
- Connector type: 2.1 x 5.5 x 9.5 mm
- Polarity: +  -

Rechargeable Li-Po Battery

- Open the battery cover at the rear of the instrument.
- Insert the rechargeable Li-Po battery with the contacts edge first.
- Close the battery cover.



Switch off the XL2  for faster recharging by mains power adapter or USB connection.



Caution

- Avoid short-circuits.
- Operate and charge the battery between 0°C and 45°C (32°F - 113°F).
- Do not heat the battery above 60°C.
- Do not place the battery in or near fire.
- Do not solder directly on to the battery.
- Do not disassemble the battery.
- Do not insert the battery in reverse polarity.

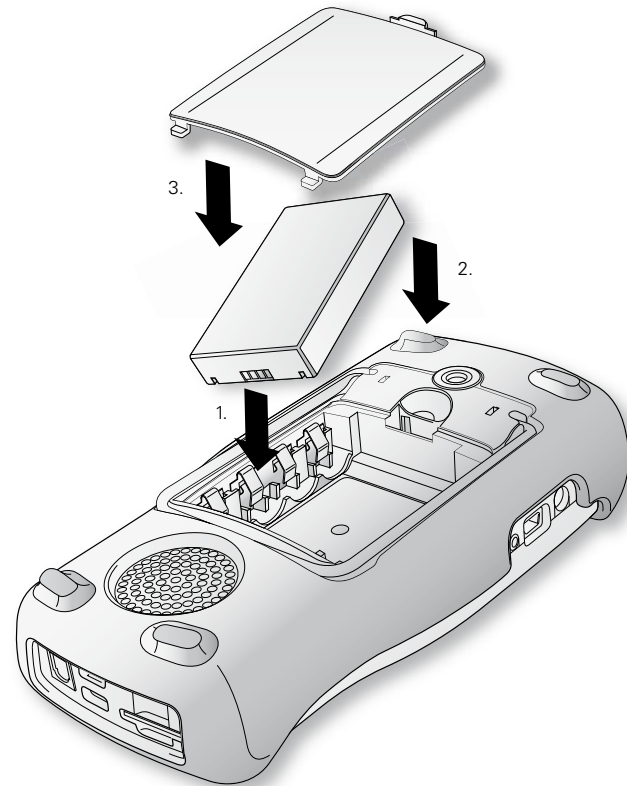

AA-Batteries

Alternatively, the XL2 can be powered by AA type batteries

- Open the battery cover.
- Insert 4 fully-charged AA batteries, observing correct polarity of the +/- indications in the battery compartment.

👉 The polarity alternates with successive batteries.

- Close the battery cover.



- Use only similar batteries from the same manufacturer.
- Replace discharged batteries with new ones.
- Do not mix used and new batteries.
- During operation, the battery temperature may increase noticeably. This is not a defect.



Remove all batteries if the XL2 is not to be used over a long period of time.

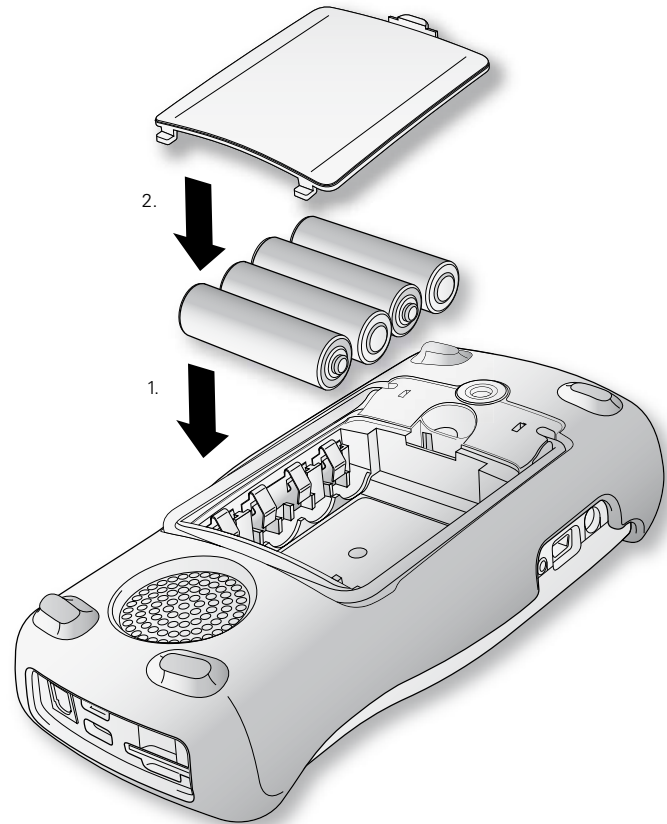

Attaching the Hand Strap

To avoid accidentally dropping the XL2, a hand strap is supplied with the instrument.

- Pull the loop of the hand strap through the opening.
- Pull the other end of the hand strap through the loop.
- Pull the hand strap tight.

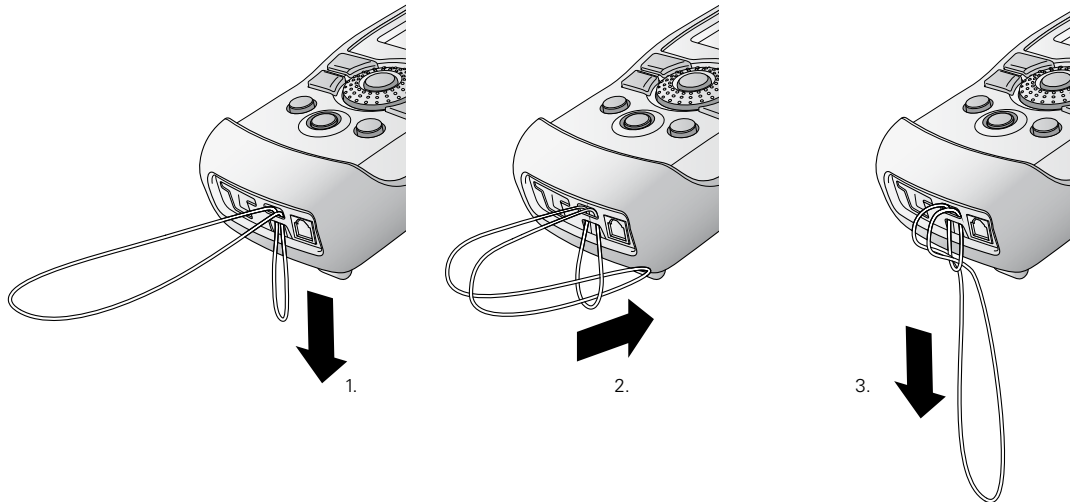

Unfolding the Stand

A convenient table stand is attached to the rear of the instrument.

- Unfold the stand and rest the XL2 on a flat surface.

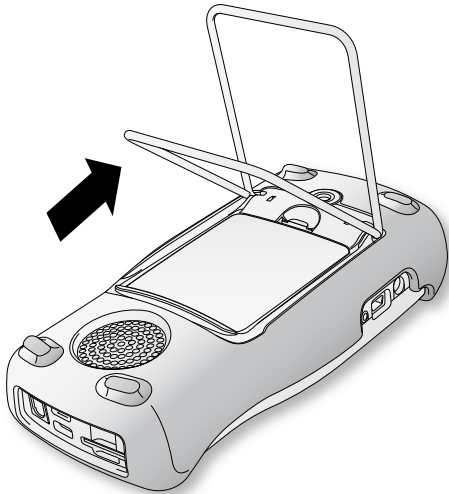

Connecting the XL2

Acoustic Measurements

Connect an NTi Audio measurement microphone to the XLR input connector of the XL2.

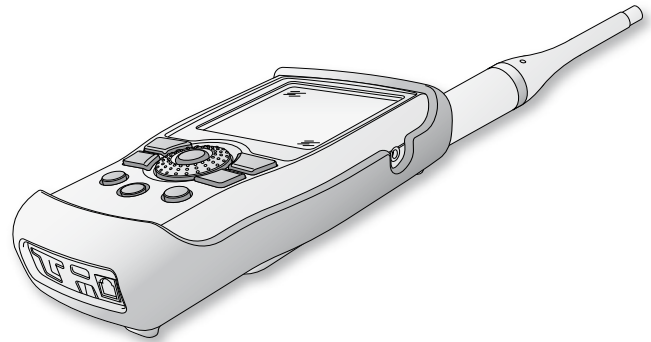

Audio Measurements: XLR Connection

- Connect the source to the XL2 with an XLR cable.
- Select the XLR input in the menu.

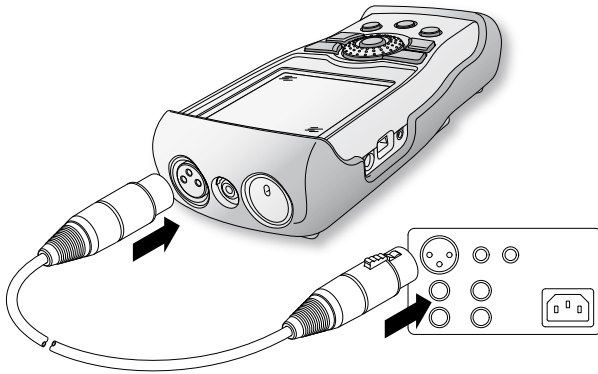

Audio Measurements: RCA Connection

- Connect the source to the XL2 with an RCA (cinch) cable.
- Select the RCA input in the menu.

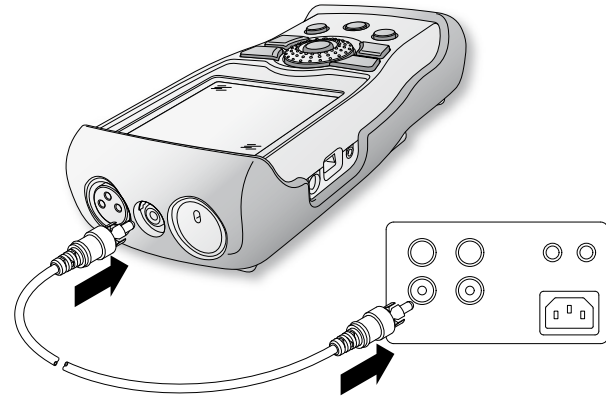

Switching the XL2 On and Off

Switching On the XL2



- Press power  to switch on the XL2.

 There is a brief sound of relays and the display illuminates.

Switching Off the XL2

- Press power  and hold it down for one second to switch off the XL2.



Select Measurement Function

- Navigate with the rotary wheel  to the main menu bar.
- Confirm with enter  to select the measurement function.

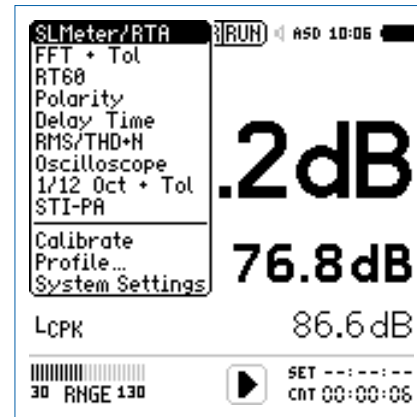
 The main menu window opens





Main menu with enabled options

- Scroll up/down with the rotary wheel  to select the required function and confirm with enter .

 The measurement function is selected.



Setting the Parameters with the Rotary Wheel

- Turn the rotary wheel  to navigate within the display screen.

 The selected parameter is highlighted with a black background.

- Confirm with enter .

 The parameter display flashes and/or available parameters or settings are shown.

- Turn the rotary wheel  to set the parameter or toggle with enter  through the settings.
- Confirm with enter .

 Now the parameter is set.

4. Sound Level Meter

The XL2 provides, together with the measurement microphone, a precise sound level meter for monitoring live sound events and/or environmental noise.

For example, Actual, Lmin, Lmax, Leq with frequency weighting A, C and Z and time weighting's F and S can be measured at the same time. All measurement results are simultaneously available. You may log all acquired level information, including real-time information, onto the removable SD Card. To complete the documentation of the measured sound pressure levels, the XL2 offers wav-file recording, as well as the facility to add voice notes for each measurement. The accuracy of the XL2 fulfills IEC 61672-1, class 1. The XL2 measures correction values between the loudest point of the live event and the actual measurement positions in accordance with DIN 15905-5 and SLV 2007.

In parallel with the wide band parameters, the XL2 measures the real-time spectrum either in 1/1 or 1/3 octave-band resolution. The RTA perfectly suits tasks such as optimization of sound systems

Extended Acoustic Pack (optional)

The Extended Acoustic Pack offers the following additional features for sound-level and acoustic measurements:



- SLMeter/RTA function
 - Percentiles for wide band and spectrum: 1%, 5%, 10%, 50%, 90%, 95%, 99%
 - Time weighting: Impulse
 - Sound Pressure Levels L_{leq}
 - Sound Exposure Level L_{AE}
 - Event-triggered audio and data recording
 - Recording of linear wav-files (24 bit, 48 kHz)
 - True peak level in 1/1 and 1/3 octave resolution
 - Clock-Impulse Maximum Level (TaktMax) and values as specified in DIN 45645-1
- FFT function
 - High-resolution Zoom-FFT with selectable frequency ranges and resolution up to 0.4 Hz in the range of 5 Hz to 20 kHz
- RT60 function
 - Reverberation time RT60 in 1/3 octave resolution

The sound level meter offers different pages:

Page Selection using the Page Button

- Press page  to toggle between the numeric result page and the RTA page.

Page Selection using the Rotary Wheel

- Select the sound level page  with the rotary wheel .
- Confirm with enter .

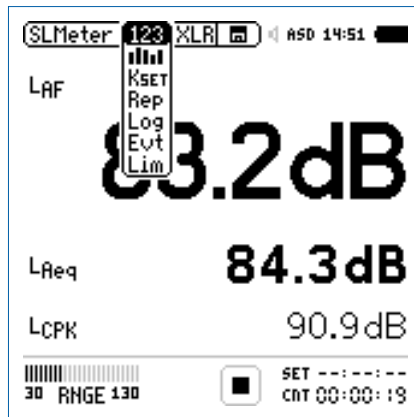

Menu with enabled options

 You have selected the individual sound level meter page.

Sound Level Meter

Displays the selected broadband sound level results. You can change the font size of the result. Depending on the font size chosen, the XL2 shows 3 or 5 results simultaneously. Individual frequency weighting, time weighting, actual, minimum, maximum and correction values can be chosen for each displayed result.

RTA Real-Time Spectrum

Displays the 1/3 or 1/1 octave spectrum of the selected sound level within the audio band. Additionally the wide band result is shown graphically by a bar.

Correction Value

This page provides a wizard to measure correction values, which could be helpful for compliant sound level monitoring of live events. It measures the correction values between the actual measurement position and the loudest position accessible by the audience. The XL2 displays and logs the selected sound pressure levels including the correction values, allowing the sound engineer to monitor the sound level at the loudest position in the audience. The measurement meets the requirements of the standards DIN15905-5 and SLV 2007. For details refer to chapter "Correction Value KSET".

Rep

Report Setting

Here you set which sound pressure levels shall be stored in a .txt file after the completed measurement. Choose between:

ALL Stores all sound pressure levels.

Selected Stores up to 10 different individually-defined sound pressure levels.

For details refer to the chapter “Report”

Log

Logging Page

The XL2 features a powerful sound level meter data logger, which allows you to record all required sound level values during the measurement. In the logging page you set which sound pressure levels shall be logged over time. Choose between:

ALL Logs all sound pressure levels.

Selected Logs up to 10 different individually-defined sound pressure levels.

For details refer to the chapter “Logging”

Evt

Event Setting (optional)

The event function is available with the optional Extended Acoustic Pack. The XL2 event feature offers the following functionalities:

- Automated event triggered at noise levels above/below a preset value including setting markers for specific noise categories. Application example: Recording the noise level for LAF > 80 dB.
- Event triggered by external keypress of the XL2 Input Keypad. You can utilize four keys (1-4) to categorize any noise of interest or noise to be later excluded in the post-processing. A typical application is categorizing any annoying industrial noise by persons living in the neighbourhood.

Lim

Limit Setting

Here you set the function of the limit LED , thereby highlighting any sound level that exceeds the pre-set limits in orange or red color.

Further, external peripherals are controlled by the optional Serial I/O Interface based on the sound level, such as displaying sound levels on a large external red-orange-green lamp.

For details refer to the chapter “Limit Setting”

Overview

Numeric Result Page

The numeric result page  displays the selected broadband sound level results. You can change the font size of the result. Depending on the font size chosen, the XL2 shows three or five results simultaneously. Individual frequency weighting, time weighting, actual, minimum, maximum and correction values can be chosen for each displayed result.

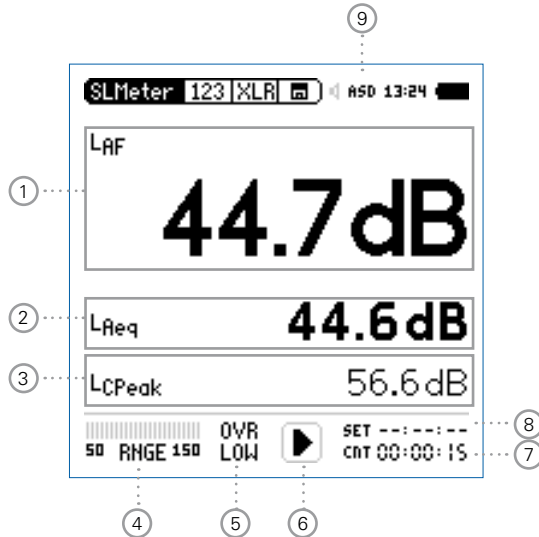

Real-Time Analyzer Page



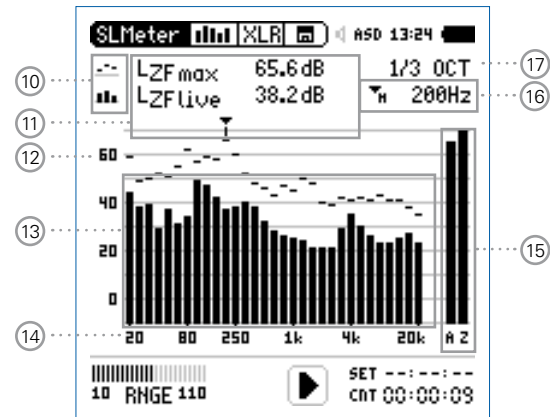

The real-time analyzer page RTA  measures and displays the 1/3 or 1/1 octave spectrum from 6.3 Hz to 20 kHz including wideband results. The real-time spectrum RTA is measured in parallel with the A and Z-weighted wideband levels.





① Sound Level Result 1

All sound levels are measured and logged simultaneously. You select which sound levels should be displayed.

Change Parameter

- Turn the rotary wheel  to select the parameter **Lxx**.
- Press enter  to open the selection menu and choose the wideband sound pressure level to be displayed.
- Turn the rotary wheel  to select the required test result parameters and confirm with enter .

Change Font Size

- Turn the rotary wheel  to select the actual test result.
- Press enter  1x, 2x or 3x to set the font size to small, medium or large.

The XL2 shows 3 sound levels on the display if a large font is chosen, otherwise it shows 5 sound levels.

② Sound Level Result 2 & 3

Follow the setting instructions for sound level result 1.

③ Sound Level Result 4 & 5

To display sound level results 4 & 5, choose a smaller font for all results. Follow the setting instructions for sound level result 1.

④ Input Range

The XL2 Analyzer provides three input ranges to accommodate the wide range of input signals. The individual ranges are based on the microphone sensitivity setting in the calibration menu of the XL2. For example at a sensitivity $S=20\text{mV/Pa}$ the input ranges are

- Lower range: 10 - 110 dBSPL
- Middle range: 30 - 130 dBSPL
- Upper range: 50 - 150 dBSPL

Select the lowest possible input range according to the maximum level expected during the measurement; e.g., if the sound pressure will always be below 110 dBSPL, then select the lowest input range 10 - 110 dBSPL.

⑤ Error Indication

OVR Overload

The error message **OVR** is displayed when:

- The measured sound pressure level exceeds the pre-set measurement range during the measurement period. Once this happens, the **OVR** indication remains displayed for the complete measurement period -> choose the next higher measurement range.
- The measured sound pressure level is just below the maximum level of the connected NTi Audio measurement microphone.

LOW Input level too low

The error message **LOW** is displayed when:

- The measured sound pressure level is below the pre-set measurement range. In this case the results shown are most likely higher than the actual measured sound pressure level -> choose the next lower measurement range.
- The measured sound pressure level is just above the residual noise of the connected NTi Audio measurement microphone, which reduces the measurement accuracy.

⑥ Run Indication

The run indication shows the measurement status running, paused or stopped. Various measurement settings are locked during ongoing measurements, such as changing the input ranging or the preset measurement time.

⑦ Actual Measurement Time

Counts actual measurement time in hrs:min:sec. Supports time modes: continuous, single and (synchronized) repeat.

Timer Mode Continuous

(applicable for standard measurements)

All values are recorded and monitored continuously after starting a measurement with start . The actual measurement time is shown.

Timer Mode Single

Automatically stops the measurement after the pre-set measurement time.

- Set the required measurement time.
- Start the measurement .

 The actual measurement time counts back to zero and the measurement ends.

- All measurement results may be recalled.



Timer Mode Repeat

Provides automated repeated measurements with user-defined, preset measurement time cycles.

- Set the required measurement time.
- Press start .



The actual measurement time counts back to zero. When the preset measurement time has elapsed, the measurement time and the measurement results are reset and a new measurement is started. All measurement results of the previous cycle are reset.

For consecutive storage of all measurement cycles, select the parameter **Naming+Saving: auto** in the memory menu. Each individual cycle result is then automatically stored to the SD Card.



Timer Mode Repeat Synchronized

Provides automated repeated measurements synchronized to the XL2 real-time clock. Press start  to begin the measurement. In order to align the selected preset measurement time with the real-time clock, the XL2 shortens the first cycle to match the real-time clock synchronization. All following measurement cycles are synchronized to the real-time clock.

For example, the cycle time setting is 30 minutes and the measurement starts at 7.50 a.m. -> the first test cycle measures from 7.50 - 8.00 a.m. Thereafter a new test cycle starts automatically for 30 minutes. The 30-minute cycles repeat until the measurement is stopped.

The measurements in the synchronized repeat timer mode start exactly on the half or full hour in accordance with DIN 15905.





Preset Measurement Time

Adjustment of preset measurement time for single and repeat timer setting.

9 Phantom Power of Microphone

The XL2 reads the electronic data sheet of any connected ASD microphones provided by NTi Audio and switches the 48V phantom power automatically on as follows:

- Connect the measurement microphone to the XL2.
- Switch on the XL2 .

 The 48V phantom power indication in the upper menu bar changes to ASD. The **XL2** is ready for acoustic measurements.

10 Result Symbols / Capture

This field offers two functions:



- Symbols for measurement results 

 Upper RTA parameter displayed as line.

 Lower RTA parameter displayed as bargraph.

- Capture

One of the displayed RTA readings may be captured. Any measurement data can then be compared with this captured reference live on the XL2 Analyzer. For example, compare the RTA spectrum of the left and right speakers.

- Select the parameter to be captured.
- Confirm with enter , to capture the reading.
- Select the upper RTA parameter  and choose **Capt.**
- Confirm with enter .

 The lower RTA reading can be compared with the previously-captured reference data.





11 Measurement Result

Actual level result of the indicated frequency band. The cursor readout displays the center frequency and the level of the band pointed to by the arrow.

 Upper parameter displayed as line.

 Lower parameter displayed as bargraph.

12 Y-Scale setting

- Select the Y-Axis with the rotary wheel  and confirm with enter .
- Select the zoom factor between **20, 10, 5, 2.5 dB/div** and confirm with enter .
- Scroll up and down with the rotary wheel  to select the Y-axis range.
- Confirm with enter .

13 RTA Measurement Result

Real-time analyzer results in 1/1 octave or 1/3 octave band resolution. Adjust the resolution at .





14 X-Scale setting

Toggles X-scale range between

20 Hz - 20 kHz RTA levels including wide band results

6.3 Hz - 8 kHz RTA levels including wide band results

6.3 Hz - 20 kHz RTA levels

- Select the X-Axis with the rotary wheel  and confirm with enter .
- Toggle with the rotary wheel  between the ranges.
- Confirm with enter .





15 Broadband Results

- A** A-weighted broadband sound pressure level
- Z** Broadband sound pressure level without any frequency weighting

16 Readout Frequency



You may select any frequency to read out individual levels. The selected frequency is indicated by the cursor arrow.

Choose between the following settings:

-  **A** The cursor follows automatically the highest level, e.g. tracing feedback frequencies at live sound.
 - Select the frequency with the rotary wheel .
 - Press enter .
 - You may readout any individual frequency.
 - Return to auto frequency with enter .

 The cursor returns to the frequency with highest level bar.



T **H** The cursor read out may be set manually to any frequency. The read out remains at the selected frequency.

- Select the frequency with the rotary wheel .
- Press enter .
- Select the frequency of interest.
- Confirm with enter .

 The cursor readout  displays the measurement results of the selected frequency band.

Setting of Test Result Resolution

Set the RTA result display to 1/1 octave or 1/3 octave band resolution as follows:

- Turn the rotary wheel  to select the parameter .
- Press enter  to toggle between **1/1 OCT** and **1/3 OCT**. to set this parameter.

Error Indications

Numeric Result Page

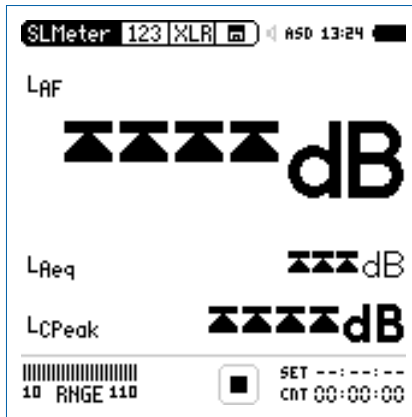

Real-Time Analyzer Page

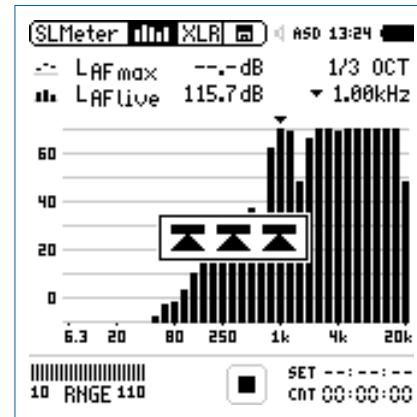



The limit arrows indicate an overload condition. Possible causes are that the sound pressure level either exceeds the pre-set measurement range, or the sound pressure level is near the maximum level of the connected NTi Audio measurement microphone. Once this happens, the **OVR** indication remains displayed for the complete measurement period -> set the next higher measurement range or reduce the input signal level as applicable.

Sound Level Meter - Getting Started

Test Preparations

The XL2 reads the electronic data sheet of any connected ASD microphones provided by NTi Audio and switches the 48V phantom power automatically on as follows:

- Connect the measurement microphone to the XL2.
- Switch on the XL2 .

 The 48V phantom power indication in the upper menu bar changes to ASD. The **XL2** is ready for acoustic measurements.



- Position the XL2 at the measurement location using a microphone stand or a tripod.
- Select the **SLMeter** function in the measurement menu and toggle with page  to the numeric result page **123**.





All wideband and RTA levels are measured and logged simultaneously. You select which sound levels should be displayed.

Select Displayed Test Result

This example describes the setting of the commonly-used actual sound pressure level L_{AF} (frequency weighting A, time weighting F).

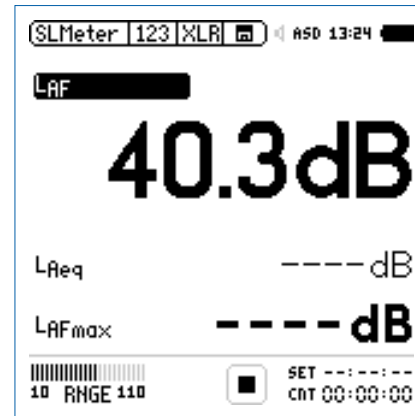
- Select the first parameter setting with the rotary wheel .
- Confirm with enter .



Press start  to measure and display the sound levels results indicated with ----.

Select Frequency Weighting

👉 The pop-up window **FREQ WEIGHTING** shows up.

- Select the frequency weighting **A**.

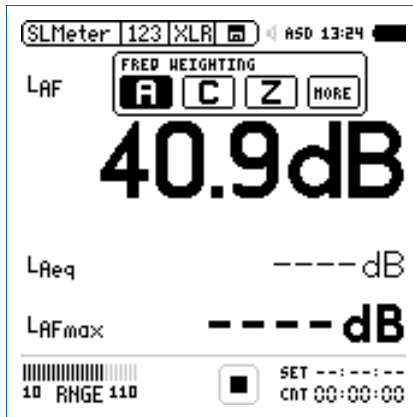

Pop-up windows shown at installed
Extended Acoustic Option

- Confirm with enter

Select Time Weighting

👉 The pop-up window extends with **TIME WEIGHTING**.

- Select the required time weighting; e.g., **F** (=Fast).

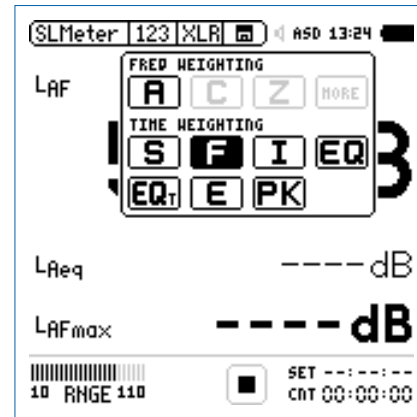

- Confirm with enter

Select Parameter

👉 The pop-up window extends with **PARAMETER** settings.

- Select the parameter **live**.

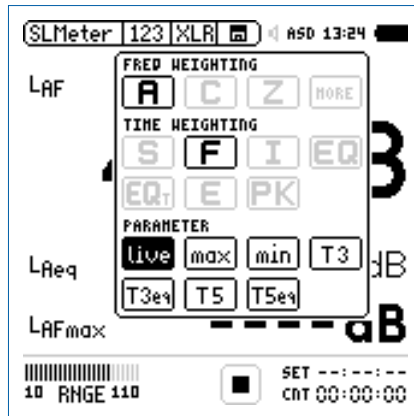

- Confirm with enter ↵.

Select Correction Value

👉 The pop-up window extends with **CORRECTION** settings.

- Select the parameter **off**.

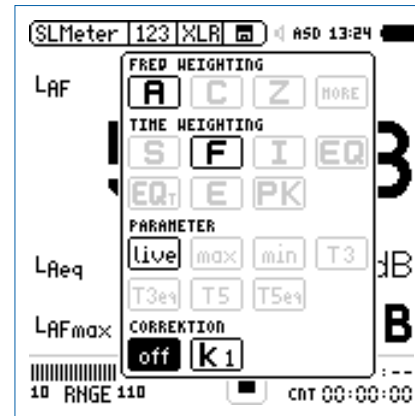

- Confirm with enter ↵.

👉 The pop-up window closes and the measured sound pressure level L_{AF} is displayed.

Select further Sound Levels



- Select further sound pressure levels as described above; e.g., L_{Aeq} and L_{AFmax} .

Select Input Range

- Select the lowest possible input range according to the maximum level expected during the measurement. Wrong input ranges are indicated by a flashing **LOW** or **OVR** message in the lower menu bar.
- Select the input range **RNGE** and press enter (↵).
- Turn the rotary wheel (⦿) to set the applicable input range and confirm with enter (↵).

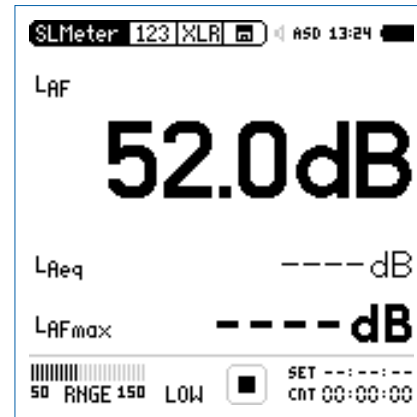

The numeric result page and the real-time analyzer page use the same input range.

Start Measurement

- The XL2 is ready to measure the sound levels L_{AF} , L_{Aeq} and L_{AFmax} .
- Press start .

👉 The run indication switches to running . The integrated sound pressure level over time L_{Aeq} and the maximum level in the measurement period L_{AFmax} are displayed. The parameter **RUN**, **LOG** (logging is enabled) or **AUD** (audio recording is configured) flashes in the memory menu.

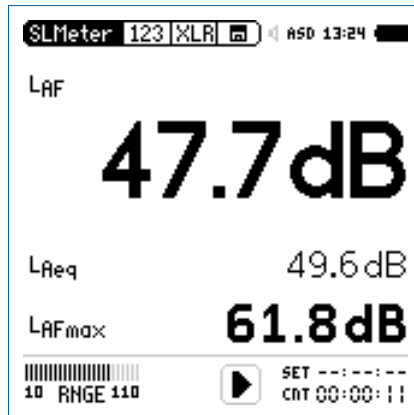

Stop the Measurement

- Press stop  to stop the measurement.

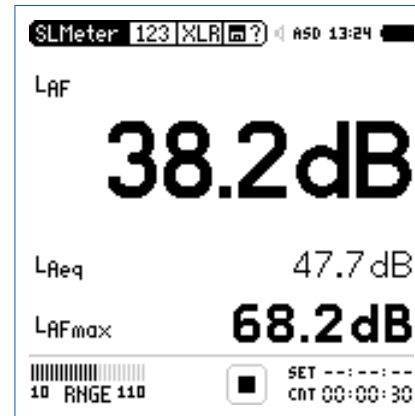

Save the Measurement Result

- Select the memory menu with the rotary wheel and confirm with enter .

The memory menu opens. **Save Test** is preselected.

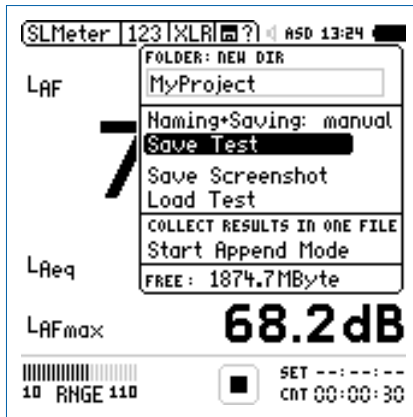

- Press enter to store the test results as an ASCII-file or select **Save Screenshot** to store the screenshot.



The XL2 stores the numeric sound pressure levels and the real-time analyzer results simultaneously.

The sound pressure level measurement is completed.

Data Post-Processing

A Microsoft Excel form generating an automated report and chart is available as free download for all registered XL2 customers on the support website at <http://my.nti-audio.com>. (Enable all macros when opening the document.)

RTA Measurement - Getting Started

Test Preparations

The XL2 reads the electronic data sheet of any connected ASD microphones provided by NTi Audio and switches the 48V phantom power automatically on as follows:

- Connect the measurement microphone to the XL2.
- Switch on the XL2

The 48V phantom power indication in the upper menu bar changes to ASD. The **XL2** is ready for acoustic measurements.

- Position the XL2 at the measurement location using a microphone stand or tripod.
- Select the **SLMeter** function in the measurement menu and toggle with page to the real-time analyzer (RTA) page .



All wideband and RTA levels are measured and logged simultaneously. You select the sound levels to be displayed.

RTA Configuration

The XL2 displays two different sound pressure levels at the same time. You configure which test results to display; e.g., LZFmax and LZFlive:

- Ensure no other measurement is going on. The run indication should display the stop symbol
- Select the **LZF** value with the rotary wheel .

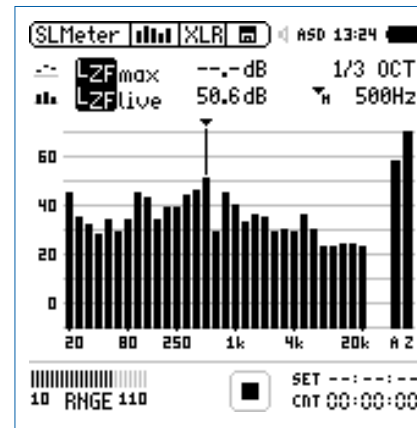

- Confirm with enter .

Select RTA Frequency Weighting

👍 The pop-up window **FREQ WEIGHTING** shows up.

- Select the frequency weighting **Z**.

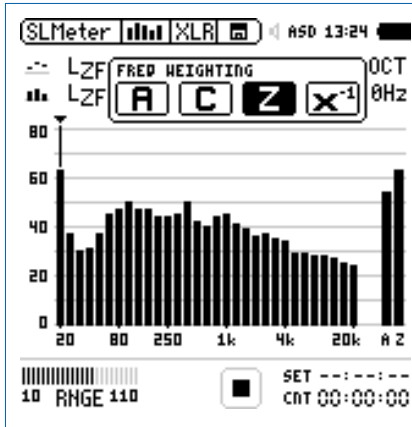

- Confirm with enter .



Press start  to measure and display the sound levels results indicated with ----.

Select RTA Time Weighting

👍 The pop-up window extends with **TIME WEIGHTING**.

- Select the required time weighting; e.g., **F** (=Fast).

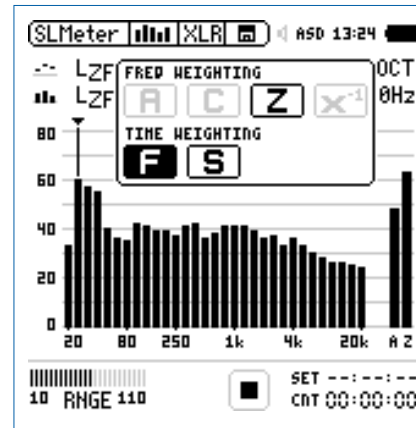

- Confirm with enter .

Select Upper/Lower RTA Parameter

- Select the parameter shown to the right of the upper **LZF** value with the rotary wheel ; e.g. **max**.
- Press enter .

The pop-up window **PARAMETER** shows up.

- Select the parameter **max**.

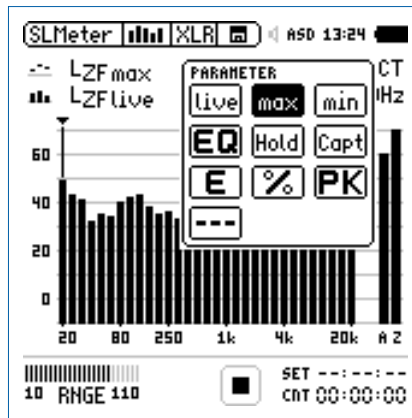

- Confirm with enter .
- Follow the same instruction and select the lower RTA parameter **live**.

Select Input Range

- Select the lowest possible input range according to the maximum level expected during the measurement. Wrong input ranges are indicated by a flashing **LOW** or **OVR** message in the lower menu bar.
- Select the input range **RNGE** and press enter .
- Turn the rotary wheel to set the applicable input range and confirm with enter .

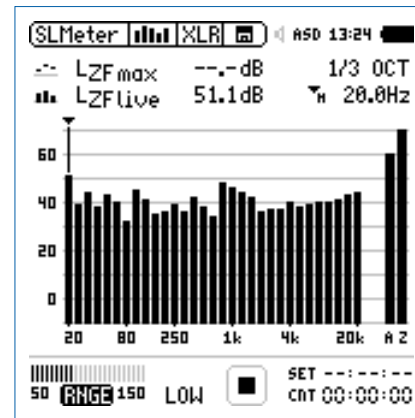

The numeric result page and the real-time analyzer page use the same input range.

Start RTA Measurement

- The XL2 is ready to display the measured sound pressure levels L_{ZFmax} and L_{ZFlive} .
- Press start

👉 The run indication switches to running . The actual sound level L_{ZFlive} and the maximum level L_{AFmax} are displayed. The parameter **RUN**, **LOG** (logging is enabled) or **AUD** (audio recording is configured) flashes in the memory menu.

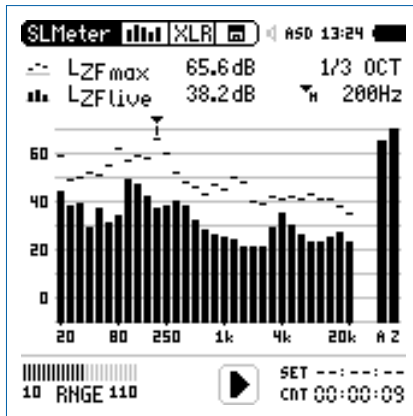

Stop the RTA Measurement

- Press stop .

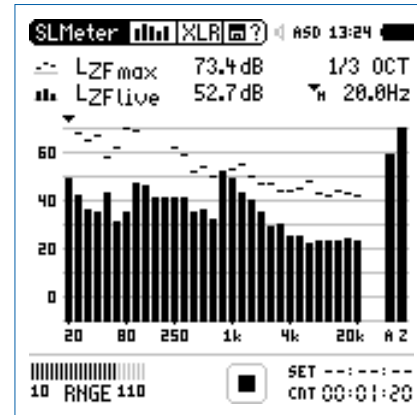



The XL2 stores the numeric sound pressure levels and the real-time analyzer results simultaneously.

Save the RTA Measurement Result

- Select the memory menu  with the rotary wheel  and confirm with enter .

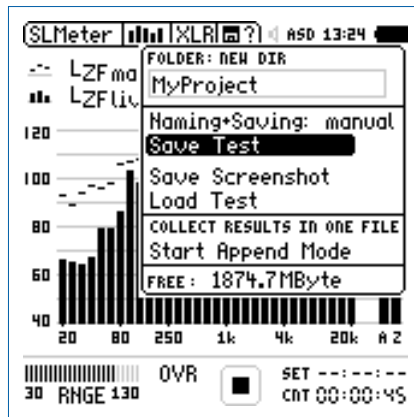
 The memory menu opens.



- Press enter  to store the test results as an ASCII-file or select **Save Screenshot** to store the screenshot.

 The RTA measurement is completed.

Correction Value KSET

The correction value page offers a measurement wizard for live event monitoring, applicable in case the measurement location differs from the loudest position in the live event area.

Measurement Position

The goal at live event monitoring is to measure the sound level at the loudest position accessible by the audience. Setting up any sound level measurement at this loudest location is typically not practical, thus an alternative measurement position is chosen. The recommended measurement position in order to minimize the influence that audience noise has on the measurement:

- Mount the measurement microphone in front of the main speakers
- Position the XL2 Analyzer at front of house (FOH)
- Connect the XL2 Analyzer and measurement microphone using a professional audio cable



Positioning the measurement microphone at front of house (FOH) may result in audience noise interfering with the measurement results. The audience noise will be further amplified by the measured k-values.

Level Difference

Prior to the start of the live event, the level difference between the loudest and the measurement position is measured. The XL2 Analyzer calculates the level difference automatically based on the individual sound level measurements at both locations. This level difference is included in the sound level reading during the live event, and the XL2 thereby displays and records the sound pressure level of the loudest point.

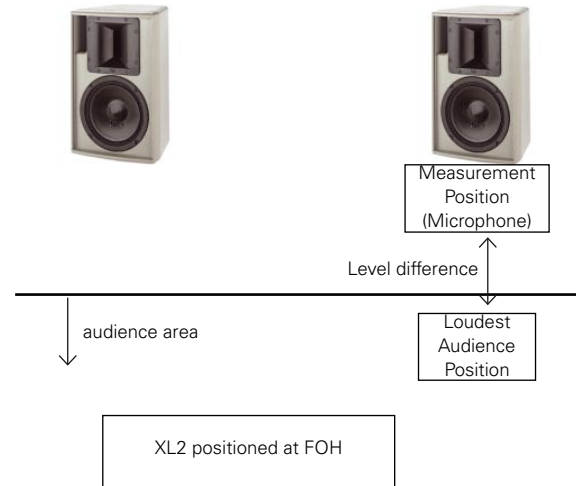

How to Measure the Correction Value

- Play a pink noise signal at the typical sound pressure level of the live event. (signal source Minirator, NTi Audio Test CD)
- Select the correction page **KSET**.
- Search the audience area for the location with the highest sound pressure level and position the XL2 Analyzer.
- Turn the rotary wheel to select the parameter **RUN** next to **Audience** and press enter .

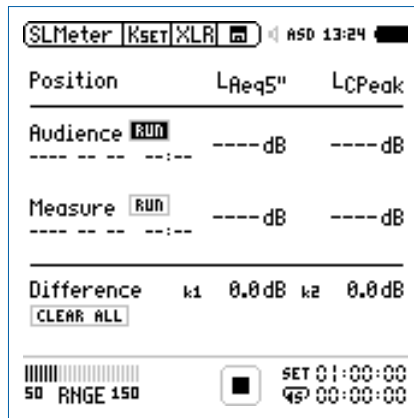

👉 The XL2 measures sound level at the loudest position for 5 seconds. The timer counts down to zero.

- Wait until the measurement is completed.
- Position the XL2 at the measurement position.
- Turn the rotary wheel to select the parameter **RUN** next to **Measure** and press enter .

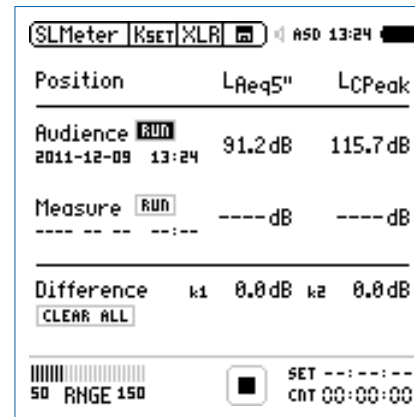

👉 The XL2 measures sound level at the measurement position for 5 seconds. The timer counts down to zero.

- Wait until the measurement is completed.
- The correction values k1 and k2 are calculated and displayed including date and time (in accordance with DIN15905).

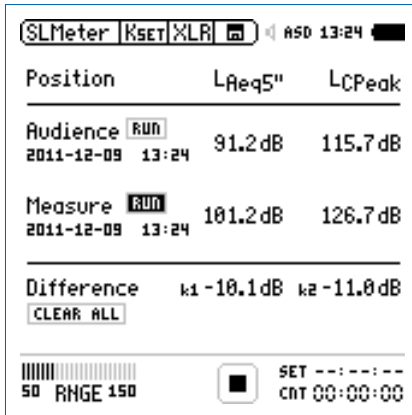





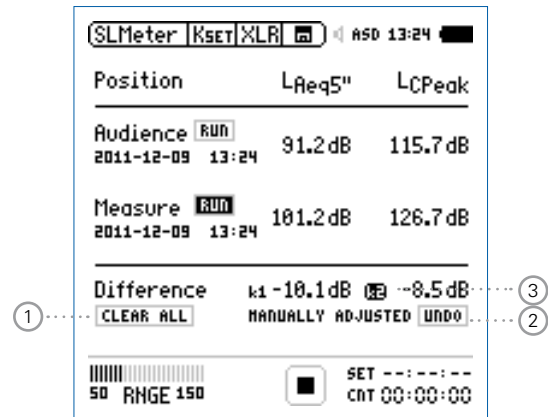

Manual Setting of Correction Values

You may fine-tune the correction values k1 and k2 manually. Such fine-tuning adds the remark "Manually Adjusted" in the log file.





- Turn the rotary wheel to select the correction value 3 and press enter .

The selected correction value starts flashing.

- Set the correction value with the rotary wheel .
-  The note “Manually Adjusted” is displayed at .
- To undo the manual setting turn the rotary wheel  to select the parameter **UNDO** at .
- Confirm with enter .



Reset Correction Values

You may clear all correction values back to zero by pressing the **Clear All**  and confirm with enter .

Display k1 and k2 during Measurement

The correction values k1 and k2 can be displayed in the numeric result page during the ongoing sound level measurement instead of any other sound levels.

Wav-file Recording

A simultaneously-recorded wav-file supports post-event reviewing of the cause of excessive sound levels.

Reporting

A report saves the conducted measurements onto the installed SD Card. The XL2 supports setting the individual levels to be stored in the report after the measurement is completed.

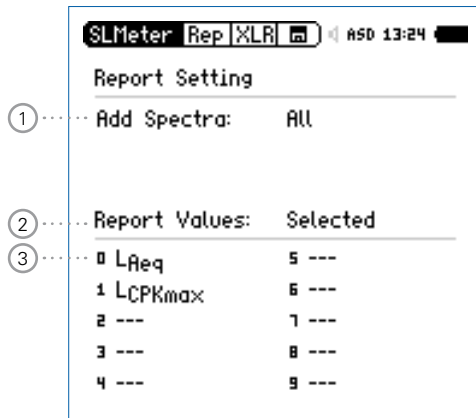

① Add Spectra

No No RTA measurement reporting.

Leq The RTA Leq level is stored in the report.

Leq, Lmax, Lmin The RTA Leq, Lmin, Lmax levels are stored in the report.

All All RTA levels are stored in the report.

② Report Values

Choose between the following result reporting:

ALL Records all available sound pressure levels without correction values.

Selected Records a subset of up to 10 different levels, including correction values if you require.

- Select **Report Values** with the rotary wheel
- Press enter to toggle between **All** or **Selected**.

③ Selected Report Values

- By setting **Selected** at ② up to 10 individual report values can be chosen. Select the first value **Lxx** with the rotary wheel and press enter .

The pop-up window for level selection shows up.



- Select the reporting level with the rotary wheel and confirm with enter .

Logging

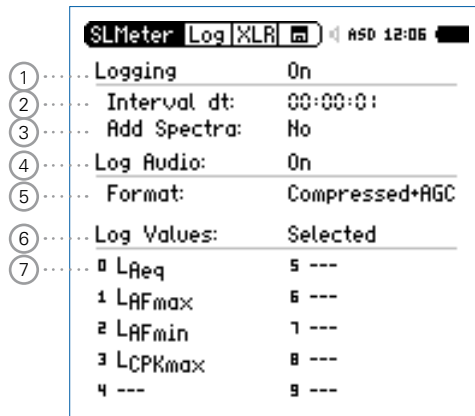
The XL2 features a powerful sound level meter data logger, which allows you to record all required sound level values during the selected period of time. All results are logged onto the SD Card. The measurement results can be loaded to a PC for documentation and visualization. The LOG menu offers the detailed setup of the log report.



① Logging On/Off

Select **Logging** with the rotary wheel  and press enter  to enable/disable the automated logging of test results.

② Interval Δt

Adjust the logging interval.

③ Add Spectra

Select **Yes** to log additionally the RTA spectrum at each logging interval.

④ Log Audio

The XL2 logs audio data as a wav-file. Choose amongst the following settings:

- Off** Audio logging is off
- On** Audio logging is activate from measurement start to stop.
- Events Only** Audio logging of triggered events only.

For more details read the chapters “Wav-File Recording” and “Events”.

5 Format



Choose amongst the following audio format recording settings:

Compressed	Compressed audio logging
Compressed+AGC	Compressed audio logging with automated gain control
24Bit_48kHz	Linear audio logging in 24 bit, 48 kHz resolution (optional with Extended Acoustic Pack)

6 Log Value Setting



Choose between the following settings:

ALL	Logs all available sound pressure levels without correction values.
Selected	Logs a subset of up to 10 different sound pressure levels, including correction values if you require.



- Select **Log Values** with the rotary wheel .
- Press enter  to toggle between **All** and **Selected**.

7 Selected Log Values

By setting **Selected** at 5 up to 10 individual log values can be chosen.

- Select the first value **Lxx** with the rotary wheel  and press enter .

 The pop-up window for level selection shows up.

- Select the logging level with the rotary wheel  and confirm with enter .

Wav-File Recording

The XL2 records a wav-file of the measured input signal and stores it on the SD Card. The available formats are:

- **Compressed** (default), using ADPCM compression. A new wav-file is started automatically after 12 hours of recording (typical maximum wav-file size = 512 MByte)
- **Compressed+AGC**, compressed with automated gain control. The gain control increases the level of low-level signals, so that the wav-file is well-leveled during playback on the PC.
- **24Bit_48kHz**, linear wav-file logging in 24 bit, 48kHz resolution with the optional Extended Acoustic Pack. A new wav-file is started automatically after 1 hour of recording (typical maximum wav-file size = 512 MByte)



Broadcast Wave Format BWF

The XL2 stores date and time of the recording within the wav-file (according to EBU TECH 3285). This information is available through professional audio/video tools typically used in broadcast.

Sample name of wav-file:

MyTest_SLM_000_Audio_FS133.0dB(PK)_00.wav



- ① **MyTest**
File name defined by user.
- ② **SLM**
Measurement function.
- ③ **000**
Automatically incrementing file number.
- ④ **Audio_FS133.0dB(PK)**
Audio file with full scale peak level. In case of a **Compressed + AGC** recording, the file name reads "AGC"; this file contains corrected level information only.
- ⑤ **00**
For wav-file recording over longer periods, the XL2 splits the audio data into individual wav-files with about 500 MB (compressed audio: 12 hours; linear: 1 hour), keeping the file size small for easier handling on the PC. The number ⑤ increments for each successive wav-file.

The advantage of wav-file recordings is to identify and document sound sources after the measurement. For example, at a live event an excessive peak level may have been measured and logged. Actually, this peak level was caused by people shouting nearby the measurement microphone, and not by the audio system being monitored. The recorded wav-file assists in verifying this and the test results can then be post-processed.



Pausing Measurement

If any ongoing measurement is paused , the XL2 continues the recording of wav-files during the paused period. The logged data and audio data can be synchronized using the stored real-time information.



Events

The wav-files are stored in a folder, named, for example, 2011-11-30_SLM_000_AudioEvent_0001-0200. The actual wav-files are named for example, as xxxx_FS133.0dB(PK).wav (xxxx = incrementing number)

Another example is environmental noise monitoring: Listening to the recorded wav-file after the measurement may help to determine the predominant sound source. The XL2 Analyzer preserves the original absolute test signal level in the recorded wav-file.

The XL2 Analyzer provides three input ranges to accommodate the wide range of input signals. The dynamic range of the recorded wav-file is set according to the selected input range. For example, at a microphone sensitivity of $S = 20 \text{ mV/Pa}$, the full scale peak level is:

Range Name	Range Level	Full scale peak level
Lower range	10 - 110 dB SPL	117.8 dB SPL
Middle range	30 - 130 dB SPL	135.9 dB SPL
Upper range	50 - 150 dB SPL	159.9 dB SPL



Select the lowest possible input range according to the maximum level expected during the measurement; e.g., If the sound pressure will always be below 110 dB SPL, select the lowest input range 10 - 110 dB SPL.

Events (optional)

The event function is available with the XL2 Extended Acoustic Pack Option. The XL2 Analyzer may be configured to record wav-files and levels of the noise only when triggered, instead of the complete measurement duration.

Advantages

Reduces the data volume acquired, thereby

- Simplifying data post-processing of the complete measurement period
- Saving data memory for long-term measurement applications.

Events

Events are triggered either automatically by sound levels above/below a preset value or manually by external keypress using the XL2 Input Keypad.

Event Functions

The XL2 event feature offers the following functionalities:

- Automated event triggered at noise levels above/below a preset value including setting markers for specific noise categories. Application example: Recording the noise level for LAF > 80 dB.
- Event triggered by external keypress of the XL2 Input Keypad. You can utilize four keys (1-4) to categorize any noise of interest or noise to be later excluded in the post-processing. A typical application is categorizing any annoying industrial noise by persons living in the neighbourhood.



Data Logging

The XL2 Analyzer logs the data specified in the LOG setting for the complete measurement duration into a log file. The markers and triggered events results are added to the same log file.

The XL2 Input Keypad is available as an accessory. Please see chapter "Options and Accessories" for details.

Trigger Events: on level above/below

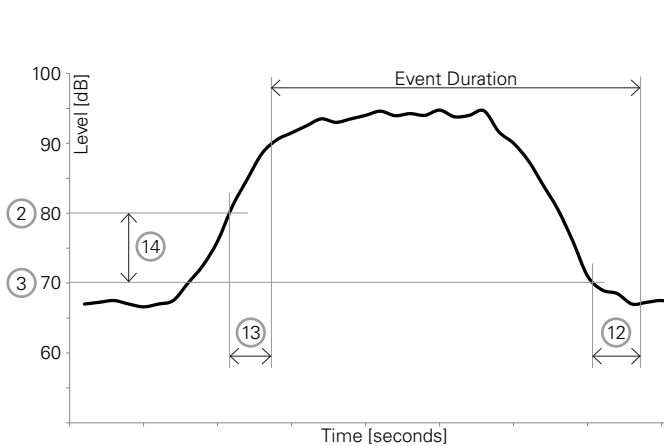

```

SLMeter Evt XLR [ ] 14:00 12:21
-----
1 Trigger Events: on level above...
2 Start [dB]: 80.0 for 02s
3 Stop [dB]: 80.0 - 10 for 03s
4 Level = LAF
-----
5 Log Audio: Events Only
6 Format: Compressed
7 Record whole event
-----
8 Status: Stopped
9 Curr Level = 64.5dB MONITOR
10 Event count: 0000 Lvl1234
  
```

Features:

- The levels L_{Aeq} , L_{Zeq} and L_{Cpeak} are recorded for the complete triggered event duration.
- Audio data are recorded for the triggered event duration only, thus simplifying data post-processing and saving memory space for long-term measurements.
- Setting markers by external keypress of the XL2 Input Keypad.

Trigger Events: on external keypress

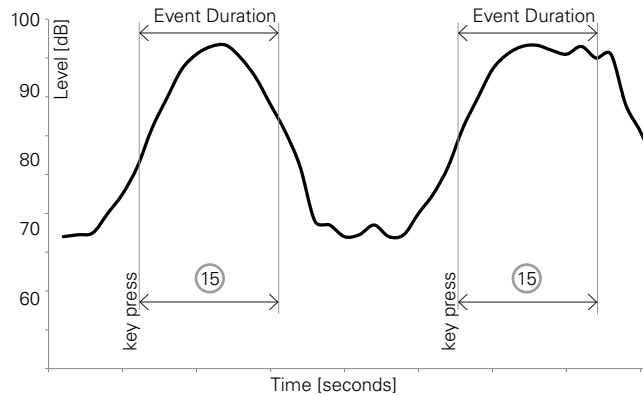

Features:

- The levels L_{Aeq} , L_{Zeq} and L_{Cpeak} are recorded for the complete triggered event duration.
- Audio data recording for the user-defined triggered event duration (15) after the keypress.
- Markers are set with every keypress

① Trigger Events

Choose from the following settings:

- Off** No event triggering
- on level above** Events are triggered at noise levels above the preset value ② for the start duration ⑬.
- on level below** Events are triggered at noise levels below the preset value ② for the start duration ⑬.
- on ext. keypress** Events are triggered by external keypress.

② Start [dB]

Set the level at which the triggered event is started.

Start Duration ⑬

The event start is triggered when the noise level is higher (or lower) than the preset value and continues for the pre-set duration.

③ Stop [dB]

Set the level at which the triggered event is stopped.

on level above Stop level = Start level ② - Hysteresis ⑭

on level below Stop level = Start level ② + Hysteresis ⑭

Stop Duration ⑫

The event stop is triggered when the noise level is lower (or higher) than the preset value and continues for the preset duration.

Hysteresis ⑭

Set the hysteresis to an appropriate value to prevent rapid switching on and off as the level drifts around the Start level.

④ Level Selection

Define the level type to be monitored.

⑤ Log Audio

The XL2 logs audio data as a wav-file. Choose from the following settings:

Off	Audio logging is off
On	Audio logging is activated from measurement start to stop.
Events Only	Audio logging of triggered events only.

For more details read the chapter “Wav-File Recording”.

⑥ Format

Choose from the following audio recording formats:

Compressed	Compressed audio logging
Compressed+AGC	Compressed audio logging with Automated Gain Control (AGC)
24Bit_48kHz	Linear audio logging in 24 bit, 48 kHz resolution. (Required for post-processing on the PC with Extended Acoustic Pack)

⑦ Audio Logging Period

If **Log Audio** ⑤ is set to **Events Only**, then the duration for the audio recording may be further specified:

Recording whole event	Records a wav-file for the whole triggered event duration.
Stop recording after	Records a wav-file for the specified period after the event start is triggered.

⑧ Status Information

Displays current trigger status:

- **Waiting for trigger**
- **Armed** (during start duration ⑬)
- **Audio + data recording**
- **Completing log cycle**

⑨ Actual Level

Measurement result of the defined level ④.

⑩ Event Counter

Counts the number of triggered events that have occurred during the ongoing measurement.

11 Trigger and Marker Monitor

Answers the question: What caused the triggered event?

Lvl Event automatically triggered by level.

- 1 Event triggered or marker added by pressing key 1 of the XL2 Input Keypad.
- 2 Event triggered or marker added by pressing key 2 of the XL2 Input Keypad.
- 3 Event triggered or marker added by pressing key 3 of the XL2 Input Keypad.
- 4 Event triggered or marker added by pressing key 4 of the XL2 Input Keypad.

12 Stop Duration

See 3.

13 Start Duration

See 2.

14 Hysteresis

See 3.

15 Event Duration at Keypress

Preset the **Min. Event Duration** when a key is pressed. If a key is pressed and held for longer than the preset **Min. Event Duration**, then the triggered event lasts for as long as the key is held.

How to Setup the XL2 for Triggered Event Measurements

- Select the logging page, set **Logging On, Interval dt: 00:00:01** and choose the required log values.
- Setup the event page. For example, the screenshot below starts the event recording after L_{AF} exceeds 80 dB for 2 seconds and stops after L_{AF} is lower than 70 dB for 3 seconds.



- Select the memory menu and create a new folder. This folder will then be displayed in the memory menu. All log data and event wav-files are stored in this folder.

👉 The XL2 is ready for the triggered event measurement.

Logging Enabled

Triggered-event recording requires the activation of sound level logging. Using the default **Interval dt: 1 second** is recommended.

Auto Save

If **Log Audio** ⑤ is set to **Events Only**, then the XL2 sets per default **Naming+Saving: auto** in the memory menu. This ensures that the recorded triggered event data is stored on the SD Card.

For convenience, in case more than 20 triggered events have been recorded, the **Autosave -> Delete** function is disabled, as deleting such multiple wav-files on the XL2 takes a long time.

Wav-files

All triggered-event wav-files are stored in an individual folder. For details see chapter "Logging".



Limits

The limit page offers two functions:

- Setup of limit LED function; enabling the XL2 to highlight any sound levels that exceed the pre-set limit in orange or red color. The default color is green.
- Limit parameter setup for external Digital I/O Adapter, which connects to the digital I/O interface. The Digital I/O Adapter is an optional accessory for the XL2 analyzer. It serves the control of any external peripherals, such as displaying sound levels that exceed limits on a big external red-orange-green lamp.

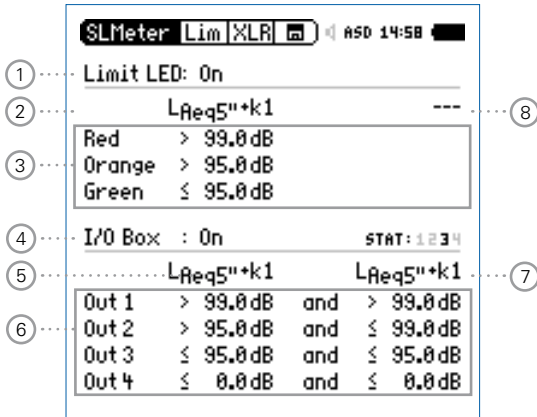

1 Limit LED On/Off

Select **Limit LED** with the rotary wheel and press enter to enable/disable the limit function.

2 LED - Level 1

Select one sound level for the limit LED indication .

- Select the sound level field with the rotary wheel .
- Press enter and select the sound level for the limit LED indication.

3 Selected Level Values

To set the level values for the limit LED ,



- Select the Red or Orange sound level in with the rotary wheel and press enter .
- Set the level value with the rotary wheel and confirm with enter .

4 I/O Box On/Off

Select **I/O Box** with the rotary wheel and press enter to enable/disable the limit function.





5 I/O - Level 1

Setup the level for the control of e.g. the external Digital I/O Adapter Box.

- Select the level field 6 with the rotary wheel .
- Press enter  and select the level for the control of the external Digital I/O Adapter Box..

6 Selected Sound Level Values

To set the level values for the control of the external Digital I/O Box.

- Select the Out 1, Out 2, Out 3 or Out 4 level in 7 with the rotary wheel  and press enter .
- Set the level value with the rotary wheel  and confirm with enter .

7 I/O - Level 2

Follow the setting for I/O Sound Level 1. The I/O level 1 may be combined with I/O level 2 using and/or combinations, providing indications in level ranges. Alternatively, other levels can be selected for the control of the external Digital I/O Adapter Box.

8 LED - Level 2

Follow the setting for LED - Level 1.



I/O Box Limits with Triggered Events

If triggered-event recording is enabled, the digital output 4 (**OUT4**) is utilized as confirmation feedback to the XL2 Input Keypad, thus the setting is disabled.

5. Acoustic Analyzer

Besides the comprehensive sound level meter function, the XL2 Audio and Acoustic Analyzer offers the following acoustic measurement functions:

- FFT Analysis with optional tolerance function
- Reverberation Time RT60
- Polarity
- Delay time
- 1/12 Octave + Tolerance Analysis (optional)
- Speech intelligibility (optional)

FFT Analysis + Tolerance

The FFT measurement is the ideal tool for visualization of comb filters and narrow band effects. It allows a detailed frequency response investigation of audio and acoustic systems. The XL2 includes an extremely fast, real-time FFT. Optional features are

- High-resolution Zoom-FFT up to 0.4 Hz steps in the frequency range 5 Hz - 20 kHz provided with optional Extended Acoustic Pack or the Spectral Limits Option
- Capture and tolerance function provided with Spectral Limits Option; thus the main menu function reads **FFT + Tol**.

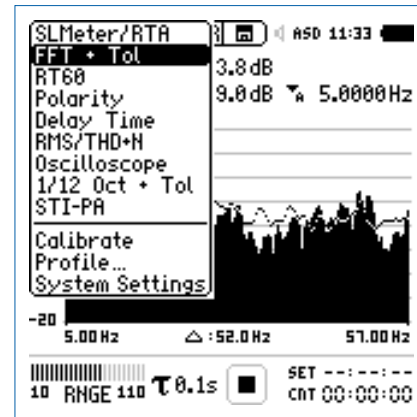

① Result Symbols / Capture & Start Tolerance Mode

This field offers two functions:

- Symbols for measurement results ②



Upper result displayed as line.



Lower result displayed as bargraph.

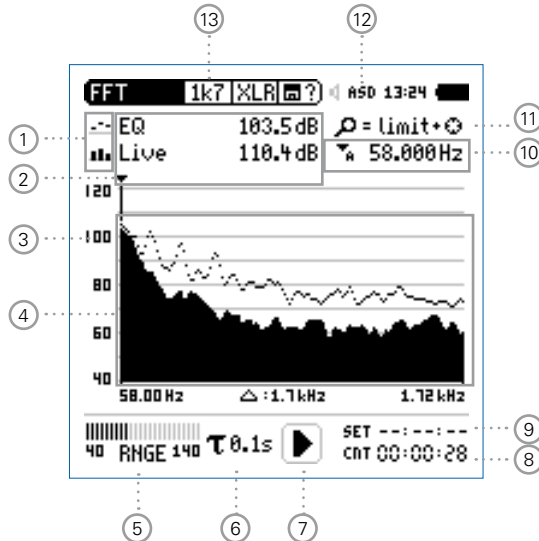

- Capture & Start Tolerance Mode

The displayed readings may be captured as reference reading C1 to C8 for

- Comparing measurement results against captured traces with relative or absolute curve display.
- Creating tolerance masks based on captured reference curves for passed / failed measurements.

Capture EQ Captures the upper parameter

Capture Live Captures the lower parameter

Manage captures

Allows to rename captures, clear recorded captures, save captures to SD-Card for export from the XL2 or load captures from SD-Card for import to the XL2.

Start tolerance mode

Starts the tolerance mode for passed/failed measurements comparing the actual measurement results against a tolerance band.

② Measurement Result

Actual level result of the indicated frequency band. The cursor readout displays the center frequency and the level of the band indicated by the arrow.







Upper parameter displayed as line.



Lower parameter displayed as bargraph.

③ Y-Scale setting

- Select the Y-Axis with the rotary wheel  and confirm with enter .
- Select the zoom factor between **20, 10, 5, 2.5 dB/div** and confirm with enter .
- Scroll up and down with the rotary wheel  to select the Y-axis range.
- Confirm with enter .

④ Measurement Result

Displays the actual and averaged measurement results.

⑤ Input Range

The XL2 Analyzer provides three input ranges to accommodate the wide range of input signals. The individual ranges are based on the microphone sensitivity setting in the calibration menu of the XL2. For example at a sensitivity $S=20\text{mV/Pa}$ the input ranges are

- Lower range: 10 - 110 dB SPL
- Middle range: 30 - 130 dB SPL
- Upper range: 50 - 150 dB SPL

Select the lowest possible input range according to the maximum level expected during the measurement; e.g., if the sound pressure will be always below 110 dB SPL, then select the lowest input range 10 - 110 dB SPL.

⑥ Time Weighting

Offers selectable time weighting of 0.1, 0.2, 0.5 and 1.0 second. Applications:

Short Time Weighting	High resolution in time with minimum averaging
----------------------	--

Long Time Weighting	Low resolution in time with longer averaging
---------------------	--

⑦ Run Indication

The run indication shows the measurement status running, paused or stopped. Various measurement settings are locked during ongoing measurements, such as changing the input ranging or the preset measurement time.

For passed/failed measurements with the Spectral Limits option the run indication may display **A** for a preset automated level trigger.

⑧ Actual Measurement Time

Counts actual measurement time in hrs:min:sec. Supports setting of time modes: continuous and single.

Timer Mode Continuous

(applicable for standard measurements)

All values are recorded and monitored continuously after starting a measurement with start .

The actual measurement time is shown.

Timer Mode Single

Automatically stops the measurement after the pre-set measurement time.

- Set the required measurement time.
- Start the measurement .

⑨ Preset Measurement Time



Adjustment of preset measurement time for single timer setting.

10 Readout Frequency

You may select any frequency to read out individual levels. The selected frequency is indicated by the cursor arrow. Choose between the following settings:



The cursor follows automatically the highest level, e.g. tracing feedback frequencies at live sound.



- Select the frequency with the rotary wheel .
- Press enter .
- You may readout any individual frequency.
- Return to auto frequency with enter .



The cursor returns to the frequency with highest level bar.



The cursor read out may be set manually to any frequency. The read out remains at the selected frequency.







- Select the frequency with the rotary wheel .
- Press enter .
- Select the frequency of interest.
- Confirm with enter .



The cursor readout  displays the measurement results of the selected frequency band.

11 Zoom Mode

(optional, applicable with the Extended Acoustic Pack or the Spectral Limits Option)

- Select the readout frequency  and press enter .
- The zoom mode is displayed above the flashing arrow.
- Select the zoom-in frequency with the rotary wheel .
- Press limit  and zoom the linear frequency scale in or out with the rotary wheel .
- Release limit  and scroll the linear frequency scale left or right with the rotary wheel .

12 Phantom Power of Microphone

The XL2 reads the electronic data sheet of any connected ASD microphones provided by NTi Audio and switches the 48V phantom power automatically on as follows:

- Connect the measurement microphone to the XL2.
- Switch on the XL2 .



The 48V phantom power indication in the upper menu bar changes to ASD. The **XL2** is ready for acoustic measurements.

13 Page Selector X-Scale and Parameter Setting

- 20k** Shows FFT result of the frequency range.
484.38 Hz - 20.594 kHz in a resolution of 141.62 Hz with 142 bins shown on the display.
- 1k7** Shows FFT result of the frequency range.
58 Hz - 1.722 kHz in a resolution of 11.72 Hz with 142 bins shown on the display.
- 200** Shows FFT result of the frequency range.
7 Hz - 215.01 Hz in a resolution of 1.47 Hz with 142 bins shown on the display.
- usr** Customized zoom mode
(applicable with optional Extended Acoustic Pack)
5 Hz - 20 kHz in zoom mode with a minimum resolution of 0.366 Hz and 142 bins displayed.
- Set** Selection for FFT Windowing:
- **Hann**: Default for acoustic measurements
 - **Dolph-Chebyshev**: for analyzing small signals (e.g. harmonics) close to a dominant signal.

The page button  switches these display modes.

FFT Analysis - Getting Started

Test Preparations

- Connect the measurement microphone to the XL2.
- Switch on the XL2
- The 48V phantom power indication in the upper menu bar changes to ASD. The XL2 is ready for acoustic measurements.
- Position the XL2 at the measurement location using a microphone stand or tripod.

Configuration

The XL2 displays two different sound pressure levels at the same time. You configure to display either the levels **Live**, **Max**, **Min**, **EQ** or captured results.

- Select the upper result parameter with the rotary wheel

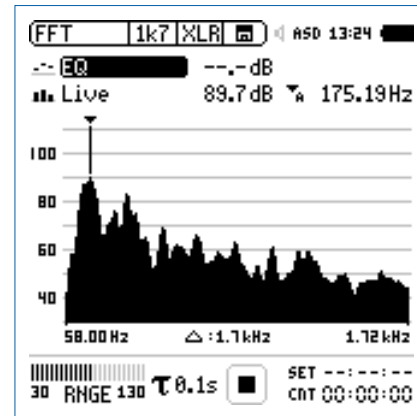

- Confirm with enter

Select Upper/Lower Reading

👉 The pop-up window **Select reading** shows up.

- Select the integrated averaged reading **EQ**. All available selections are Z-weighted (= no weighting).

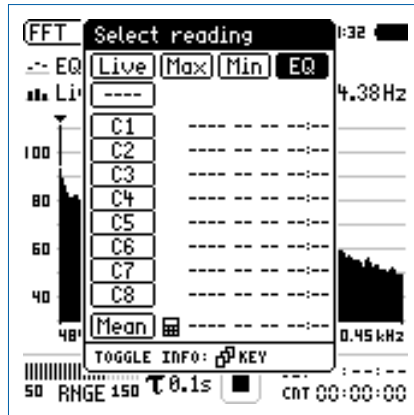

- Confirm with enter ↵.

👉 The pop-up window **Select reading mode** shows up.

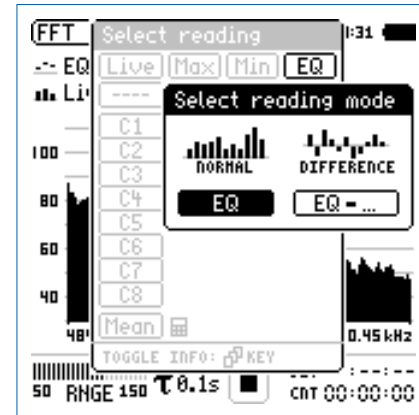

- Select **EQ** for normal absolute display of measurements.
- Follow the same instruction and select the lower FFT reading **Live**.



Press start  to measure and display the sound levels results indicated with ----.

Select Input Range

- Select the lowest possible input range according to the maximum level expected during the measurement.
- Select the input range **RNGE** and press enter
- Turn the rotary wheel to set the applicable input range and confirm with enter .

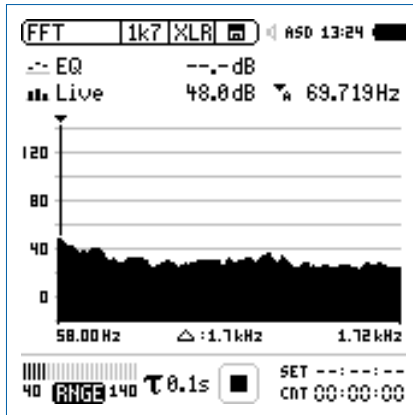

Start and Stop the Measurement

- The XL2 measures the selected sound pressure levels **Live** and **EQ**. All available sound levels are Z-weighted (= no weighting).
- Press start .

The run indication switches to running . The actual sound level Live and the averaged level EQ are displayed. The parameter **RUN** flashes in the memory menu.

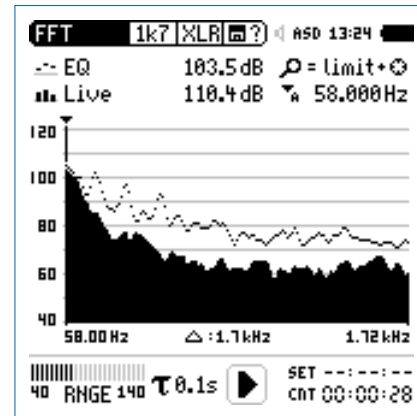

- Press the stop button to stop the measurement.

Save the FFT Measurement Result

- Select the memory menu with the rotary wheel and confirm with enter .

The memory menu opens.

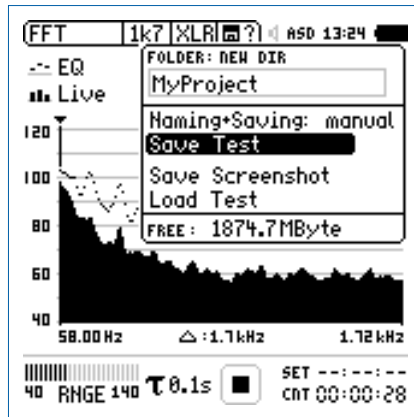

- Press enter to store the test results as an ASCII-file or select **Save Screenshot** to store the screenshot.

The FFT measurement is completed.

Capture References and Create Tolerances

The Spectral Limits Option extends the function range of the XL2 with trace capturing, relative curve display and comprehensive tolerance handling for the **FFT** Analysis and the high resolution **1/12 Oct + Tol** spectral analysis.

Features:

- Captures multiple traces in the internal memory
- Comparing measurement results against captured traces with relative or absolute curve display
- Comprehensive tolerance handling
- Creating tolerance masks based on captured reference curves for passed / failed measurements
- Export and import of tolerance and capture files
- True peak level in 1/1 and 1/3 octave resolution
- High-resolution Zoom-FFT up to 0.4 Hz steps in the frequency range 5 Hz - 20 kHz

Read the detailed description in the separate chapter "Capture + Tolerance" in this manual.

Reverberation Time RT60

The XL2 measures the energy decay from 63 Hz to 8 kHz using the Schroeder method. Use either an impulse source (e.g., a starter pistol) or a gated pink noise as the test signal.

What is Reverberation Time RT60?

Reverberation time RT60 is the time required for the sound pressure level to decrease by 60 dB after the sound stimulus measurement is stopped. Since ambient noise often defeats the measurement of a 60 dB level decrease in practice, it is difficult or even impossible to measure a 60 dB decay. Thus the XL2 Analyzer measures the reverberation time as T20 results.

$$T20 = 3 \times \text{decay time of } 20 \text{ dB}$$

In detail the reverberation time RT60 is based on a linear least-squares regression of the measured decay curve from -5 dB down to -25 dB according to ISO3382. Utilizing the T20 method it is sufficient to create a test level at least 35 dB above the background noise within each frequency band. Please see the next drawing for details.

If the overall RT60 is short (e.g. < 0.3 seconds) the room acoustic is referred to as being “dead”; for example, a heavily furnished room with thick carpets, curtains and upholstered furniture may have such an acoustic character.

If the overall RT60 is long (say more than 2 seconds) the room acoustic is referred to as being “live” and echoic; for example, a large empty room with painted plaster walls and a tiled floor may have such an acoustic character.

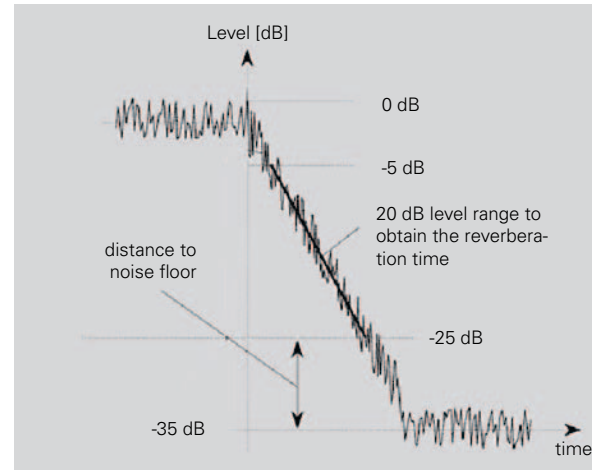

RT60 Run Page **RUN**

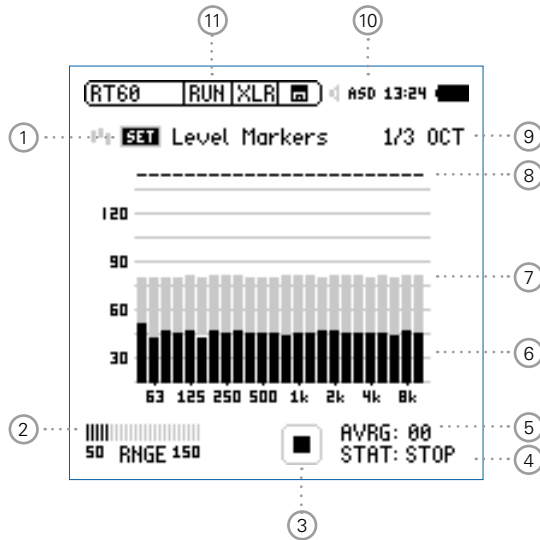

RT60 Average Result Page **RES**

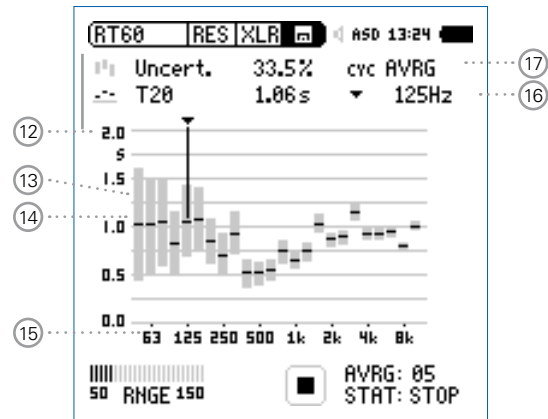

RT60 Cycle Result Page

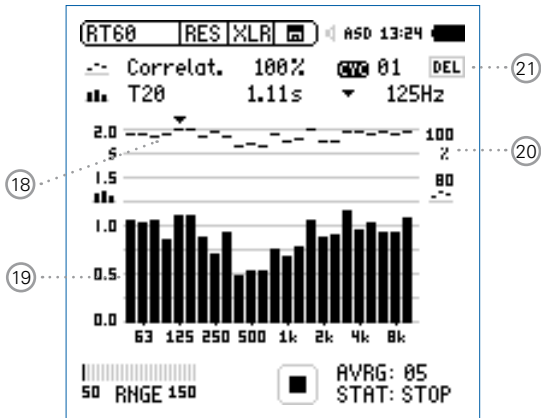

① Set Level Markers

Prior to conducting a reverberation time measurement, the environmental noise is measured, and the required energy level of the test signal is determined.

- Select **SET** and press enter (↵) to measure the actual environmental noise.

👉 The required level markers appear in grey color.

② Input Range

Select between the lower, mid and upper input range. The exact ranges depend on the microphone sensitivity setting in the calibration menu of the XL2.

③ Run Indication

This icon displays the running and stop status of the reverberation time measurement. It is controlled by start/stop (▶■).

④ Measurement Status STAT

Displays the actual measurement status. Start and stop the reverberation time measurement with start/stop . The following status information is displayed:

ARMED Measurement is waiting for the test signal to exceed at least one measurement trigger marker, then the measurement is triggered automatically.

NOISE A sound stimulus signal above the trigger marker is being received.

DECAY Decay is being measured.

PAUSE The measurement has been paused by pressing pause .

STOP No RT60 measurement is presently being performed.

⑤ Average AVRG



Counts the measurement cycles. When using a gated noise test signal, a minimum of 3 sequential cycles is recommended.

⑥ Actual Real-Time Spectrum

The black bars indicate the actual signal, including background noise. While setting up the reverberation time measurement you should increase the test signal level until the black bars exceed the grey bars completely and the status  displays **NOISE**.

⑦ Level Marker

The grey bars indicate the signal level required for effective reverberation time measurements in each octave band. The marker has a length of 35dB, and can be set by

- Selecting **SET**  with the rotary wheel .
- Press enter  to measure the environmental noise in the silent room.

⑧ Band Status

Indicates a successful reverberation time measurement above each octave band with a tick .

⑨ Measurement Resolution

Reverberation time measurement selectable in 1/3 octave or 1/1 octave band resolution.

10 Phantom Power of Microphone

The XL2 reads the electronic data sheet of any connected ASD microphones provided by NTi Audio and switches the 48V phantom power automatically on as follows:



- Connect the measurement microphone to the XL2.
- Switch on the XL2 .

 The 48V phantom power indication in the upper menu bar changes to ASD. The **XL2** is ready for acoustic measurements.

11 Page Selector RT60

Select between the RT60 run page and the test result page. The page button  toggles between these displays.

 RT60 run page

 RT60 result page. Toggle with the measurement result selection  amongst

AVRG RT60 result page showing average of all cycles and uncertainty factor

CYC xx RT60 result page for each cycle

Last RT60 result page for last cycle

12 Y-Axis Reverberation Time

Reverberation time in seconds. The scaling is automatically adjusted.

13 Uncertainty Factor

The uncertainty factor is displayed in the RT60 average result page. It indicates the uncertainty of the averaged measurement results, reduces as more cycles are measured, and depends on the measured reverberation time and the bandwidth of the individual frequency band; lower bands show a higher uncertainty factor. The number of measurement cycles is displayed at 5.

14 Overall Reverberation Time Test Result

Readout of reverberation time and uncertainty factor.



Uncertainty factor. For more details see 13.



Reverberation time measurement results.

15 X-Axis

RT60 Octave Bands 63Hz - 8 kHz

16 Cursor Readout

Select the individual frequency band and read out the following numeric measurement results

- Uncertainty factor in % or correlation in %.
- Reverberation time RT60 (T20), of the selected frequency band, in seconds (s).

17 Measurement Result Selection

The RT60 measurement function allows consecutive measurements within one test sequence. An averaged test result of all measurements is automatically calculated.

Select **CYC** and scroll with the rotary wheel through the individual test result cycles showing

Last Last Test Result

Displays the result of last measurement cycle.

xx Single Test Cycle Results

The individual single test results are marked with **CYC xx**, where **xx** is an incriminating number. You may delete individual test results. The averaged reverberation time result uses only the remaining valid measurements. To delete results in a cycle,

- Select **DEL** with the rotary wheel
- Confirm with enter

AVRG Averaged Test Result

The averaged test results of all cycles are calculated and displayed.

18 Correlation Factor in %

The correlation factor is 100% for perfectly linear sound pressure level decay after the sound source has ceased. The natural deviation from this linearity results in lower correlation values. The correlation factor is typically 80 - 100%.

19 Cycle Reverberation Time Test Result

Readout of cycle reverberation time and correlation factor 18 when selection 17 is **CYC xx** or **Last**.

 Correlation Factor. Scale is on the right Y-axis. For more details see 18.

 Reverberation time measurement result of individual displayed cycle. Scale is on the left Y-axis.

20 Y-Axis Correlation Factor

The right Y-axis shows the correlation factor in %. The correlation factor Y-axis is displayed when test result selection 17 is **CYC xx** or **Last**.

21 Delete Cycle Results

Individual cycle results may be deleted, thereby excluding them from the calculation of the **AVRG** result.



Test Signals

The sound source shall be as omnidirectional as possible. Use either a gated pink noise or an impulse source as the test signal.

- Gated pink noise
Various gated pink noise test signals with different on/off times are offered by the NTi Audio Test CD included with the XL2 or the Minirator signal generator.

- Impulse
The trigger signal is a generated impulse source, such as a starter pistol. Individual measurements, or test sequences with repeated trigger signals, can be carried out.

Ideally the XL2 should measure the reverberation time of several on/off cycles and automatically average the reverberation time results. The uncertainty factor is calculated after a minimum of three measurement cycles.

RT60 Measurement - Getting Started

Test Signal: Pink Noise

Play a pink noise signal through an omni-directional speaker in the room under test. The sound source should be played for a long enough time period to ensure that a balance between injected and absorbed acoustic energy has been reached. For example the sound reflections should be given enough time to reach all reflective surfaces in the room. As a rule of thumb, ensure that the pink noise is played for at least the time period of the estimated RT60 test result. If in doubt, play the Minirator MR-PRO or the Test Signal CD as sound source for at least 5 seconds for each cycle. Each time the source signal stops, the XL2 recognizes this interruption, triggers, measures the decay time and calculates the reverberation time automatically.

Test Signal: Impulse

Fire an impulse sound source in the room under test, e.g. use a starter pistol. The XL2 measures the decay time and calculates the reverberation time automatically. Do not fire the next shot until the previous calculation is complete i.e. until the status ④ displays **ARMED**.

Test Preparations

The XL2 reads the electronic data sheet of any connected ASD microphones provided by NTi Audio and switches the 48V phantom power automatically on as follows:

- Connect the measurement microphone to the XL2.
- Switch on the XL2 .

 The 48V phantom power indication in the upper menu bar changes to ASD. The **XL2** is ready for acoustic measurements.

- Position the XL2 at the measurement location using a microphone stand or tripod.
- Select the **RT60** function in the measurement menu and toggle with page  to the run page **RUN**.
- Prepare the environment for the measurement. For example mute all sound sources to establish silence.

Set Level Markers

- Select the parameter **SET** with the rotary wheel and press enter .

The environmental noise is measured and the grey level markers are set.

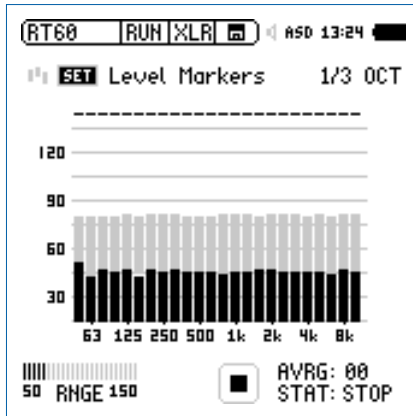

Get Ready for the Reverberation Time Measurement

- Protect the ears against high sound pressure levels, as the test signals might be very loud.

Setting the pink noise level:

- Start the pink noise test signal with the appropriate on/off time according to the room. Use an initial low level.
- Increase the test signal level until all level markers for the minimum test signal level are passed. Use an equalizer to push individual band levels.
- Switch off the gated pink noise signal after you have finished setting the pink noise level.

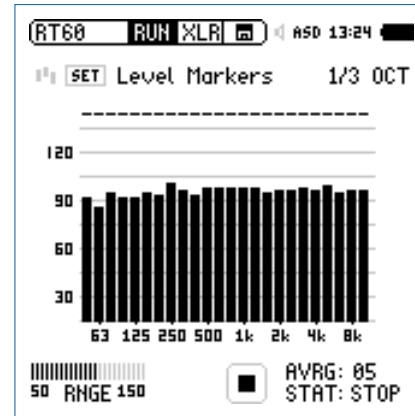

Start the Measurement

- Press start . The status indication switches to **ARMED**.
- Enable the test signal; e.g., switch on the gated pink noise signal or fire a starter pistol.
- The black bars have to exceed the grey bars completely.

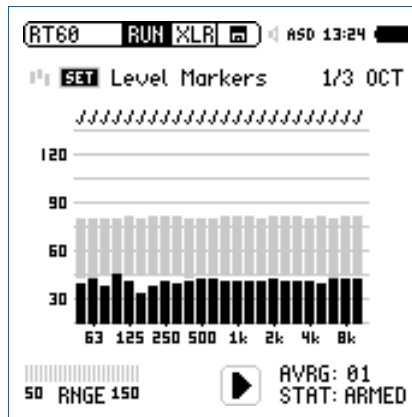

- The RT60 calculation cycle is complete when the sound pressure level falls below the bottom of the grey level markers in every band.
- Confirmation marks ✓, indicating successful measurements, are displayed above each band.

Continue the Measurement

Using pink noise:

The gated pink noise test signal continues with the preset on/off time. The XL2 automatically triggers at each cycle. Complete a minimum of three test cycles to accurately calculate the uncertainty factor.

Using an impulse source:

Use further starter pistol shots to repeat the measurements.

- Press pause to pause the measurement.
- Prepare the next impulse sound source; e.g., starter pistol.
- Press start to continue the reverberation time measurement.
- Enable the test signal; e.g., fire the starter pistol.

An automated algorithm calculates the averaged reverb time of all measurement cycles.

Stop the Measurement and Read Out the Result

- Press stop after all cycles are completed.
- If applicable, switch off the pink noise test signal.
- Select the result page **RES** with page .



The average reverberation time for each frequency band is displayed in seconds and the measurement uncertainty in %. For more details refer to the chapter "Reverberation Time RT60".

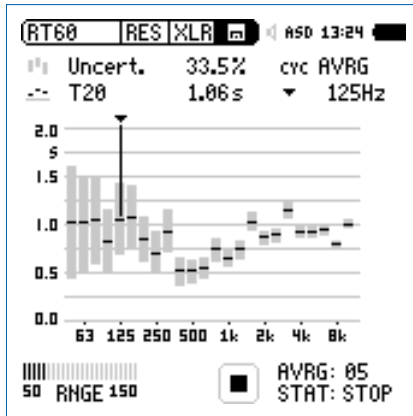

Read Out the Individual Cycle Result

- Select **CYC** with the rotary wheel , press enter and select the individual cycle result with the rotary wheel .



Within each cycle, the reverberation time for each frequency band is displayed in seconds and the correlation factor in %. For more details refer to the chapter "Reverberation Time RT60".

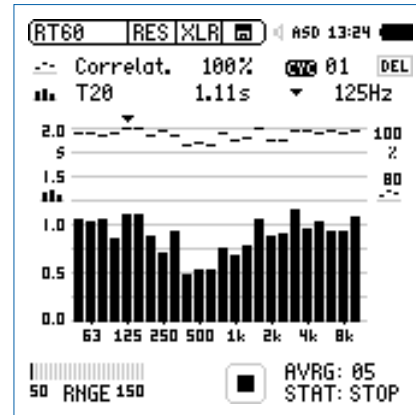

The RT60 reverberation time measurement is completed.

Error Indications

Various error indications are displayed for unsuccessful RT60 measurements. Corrupt cycles can be deleted individually. These results are then excluded from the average calculations.

- **LOW LEVEL**

This is the abbreviation of “low test signal level” during the measurement. Increase the test signal level until the black level markers exceed the grey level markers in every frequency band. Also, ensure that the level falls below the grey level markers, otherwise use a RT60 test signal with longer on/off times.

- **CORR<70%**

The correlation factor is lower than 70% indicating an unreliable measurement result.

- **T>18S**

The measured reverberation time exceeds the time limit of 18 seconds. This is commonly caused by either an incorrect analyzer range setting or environmental noise. In the first case, choose another range setting. In the second case, ensure that the environmental noise remains constant during the measurement, and/or **SET** the level markers again while the environmental noise is high.

Polarity

Polarity measurement is important in matching the left and right speakers for a good stereo sound image. The polarity function measures the polarity of cables, single speakers and speaker cabinets. For testing, use the polarity signal provided on the NTi Audio Test CD or the Minirator test signal generator.

The polarity of individual speakers or speaker cabinets might change with the frequency. For example, the mid-range speaker polarity may differ from the woofer polarity within the same speaker cabinet. Therefore the polarity detailed result page of the XL2 displays the measured polarity of the individual octave bands from 125 Hz to 8 kHz. This allows in-depth verification of the polarity - frequency relationship.



- Polarity is a simple test within the very complex science of signal phasing. Drivers, speakers and crossovers all cause phase shifts of the audio signal.
- The polarity of various speakers within the same cabinet may differ by design!
- Polarity testing is useful for checking the correct wiring of similar speaker systems.

Positive/Negative Page

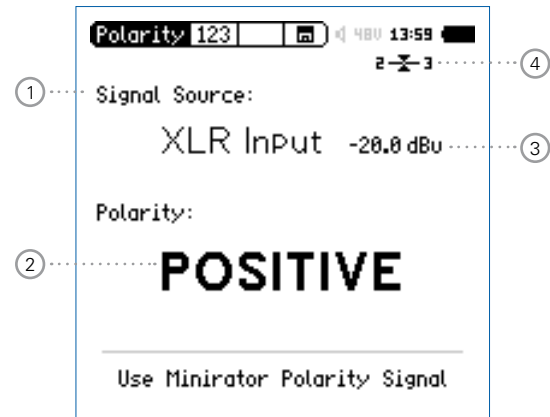

Detailed Result Page

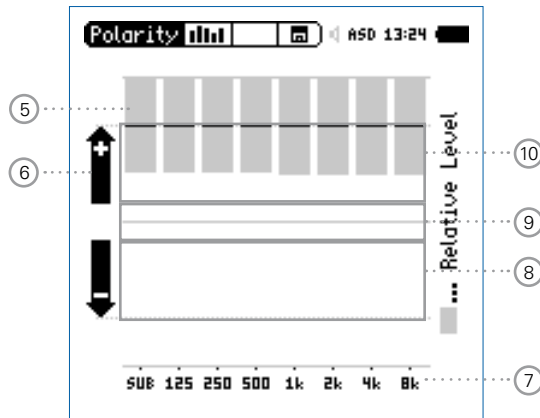

Polarity result for Minirator
connected directly to XL2 Analyzer

① Input Selection

Select the signal source as follows:

- Select **Signal Source** with the rotary wheel
- Press enter to select either

Voice Note Mic Use the internal voice note microphone of the XL2 for polarity measurements. This selection disables the rear speaker.

XLR Input Measure the acoustic polarity with a measurement microphone. Alternatively, measure the polarity of an electrical signal connected with an XLR audio cable.

RCA Input Measure the polarity of an electrical signal connected with an RCA audio cable.

② Polarity Test Result

Displays either **POSITIVE**, **NEGATIVE** or **???** (=undefined). For further visual indication, the limit button illuminates green for **POSITIVE** and red for **NEGATIVE** polarity.

③ Level RMS

Measures the absolute level of the input signal. The unit's dBu, dBV and V are selectable.

④ Balance Indicator

Indication of the audio signal balance between pin 2 and 3 on the XLR input for input signals > -34 dBu.



The input signal is balanced.



The signal is unbalanced. The level of pin 2 is higher than pin 3.



The signal is unbalanced. The level of pin 3 is higher than pin 2.

⑤ Relative Level Indicator

The grey area shows the measured signal energy within the individual frequency bands. The bands with the biggest energy have the most effect on the actual displayed **POSITIVE / NEGATIVE** polarity result.

⑥ Polarity Indication

- + Polarity of frequency band is positive. The polarity result is in the upper display area; the + area.
- Polarity of frequency band is negative. The polarity result is in the lower display area; the - area.

⑦ X-Axis

Seven octave bands with center frequencies from 125 Hz to 8 kHz. **SUB** displays the polarity of Sub-woofers; frequency range < 100 Hz.

⑧ Negative Polarity Area

Measurement results area with negative polarity (-). The black line in the middle of relative level indicator ⑤ displays the measured polarity of the individual frequency band. The dashed line indicates the lower limit of the measurement result area.

⑨ Uncertain Polarity Area ???



Polarity results for frequency bands in this area are uncertain. Therefore the polarity result ??? is displayed.

⑩ Positive Polarity Area

Measurement results area with positive polarity (+). The black line in the middle of relative level indicator ⑤ displays the measured polarity of the individual frequency band. The dashed line indicates the upper limit of the measurement result area.

Polarity Measurement - Getting Started

For acoustic polarity measurement you can use the internal voice note microphone, or an external measurement microphone, plugged into the XLR input. The polarity result for left and right speaker cabinets should match for a good stereo sound image.

- Feed the speaker cabinet with the polarity test signal of the Minirator.
- Adjust the test level (at Minirator or amplifier) until the test signal is clearly heard.
- Enable the polarity test signal at the left speaker cabinet; mute the right speaker cabinet.
- To activate the internal microphone, select **Signal Source** with the rotary wheel  and choose **Voice Note Mic** with enter .
- Measure the polarity of the left speaker cabinet and save the screenshot in the memory menu .
- Enable the polarity test signal at the right speaker cabinet; mute the left speaker cabinet.
- Measure the polarity of the right speaker cabinet.
- Compare the polarity test result of both speaker cabinets.

 The polarity measurement is completed.

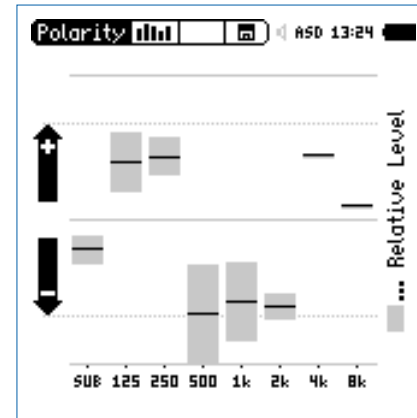

The sample result shows the polarity as:

- Sub-woofer: Low energy, no sub installed
- Woofer: Positive
- Mid-range: Negative
- Tweeter: Positive (with small levels)

The major part of the signal energy is measured in the mid-range frequency bands. Therefore the overall displayed polarity is **NEGATIVE**.

Delay Time

The delay time measurement function is suitable for accurate configuration of delay line setups, by optimizing the directionality of the signal source. The XL2 measures the delay time between the reference signal and the acoustic signal from the speaker. The acoustic delay settings are displayed, allowing you to easily set the measured delay time into the delay device in the rack.

The NTi Audio delay time test signal is provided either by the Minirator MR-PRO, MR2 or the Test CD included with the XL2.

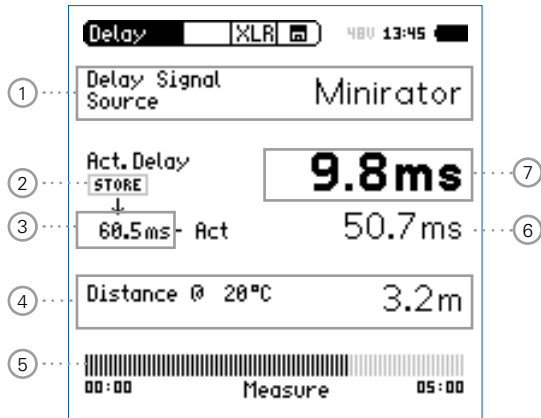

① Delay Signal Source

Select the signal source for the delay measurement:

CD Player Using the supplied NTi Audio Test CD; this setting implies the synchronization time bar is set to 100 seconds = 1 min. 40 sec.; after 100 seconds the XL2 has to be synchronized to the delay test signal again.

Minirator Due to compatibility and the accuracy of the Minirator, MR-PRO and MR2 test signals, the XL2 offers an extended time range without synchronization. Only after 300 seconds (5 minutes) does the XL2 have to be synchronized to the delay test signal again.

② Store Button

Press the store button to record the actual delay (7) of the reference speaker.

③ Reference Delay Time

Individually-stored reference delay time; e.g., speaker A as described in the following chapter "Delay Measurement - Getting Started".

④ **Calculated Distance**

Distance from measurement position to speaker in meters or feet, based on the defined temperature in °C or °F

⑤ **Synchronization Time Bar**

The automated synchronization allows delay time measurements without any connected electrical reference signal for 100 seconds using the NTi Audio Test CD or 300 seconds using the Minirator, MR2 or MR-PRO. It displays the time remaining until the next required synchronization.

⑥ **Calculated Delay Time: Store - Actual**

Calculated difference between delay time of speaker A and speaker B as shown on the next page. The automated difference calculation simplifies the verification of delay line arrangements, such as those used in larger halls or auditoriums.

⑦ **Actual Delay**

Actual measured delay time referring to the electrical reference signal.



Delay Test utilizes VoiceNote Microphone

The XL2 uses the internal VoiceNote microphone to measure the acoustic delay. Do not connect any measurement microphone to the XL2 for the delay time measurement.



Rear Speaker

The rear speaker on the XL2 is disabled during delay measurements, thereby avoiding measurement failures. The headphone output is active.

Delay Measurement - Getting Started

The delay time measurement is conducted between the synchronized electrical input signal and the acoustic signal measured by the built-in voice note microphone. In this example, the delay between speakers A and B in the illustrated auditorium is measured.

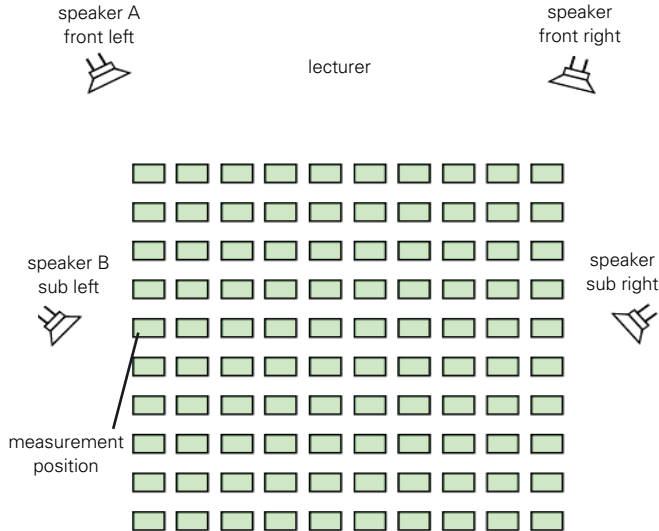

Test Preparations

- Prepare the delay test signal; use either the
 - NTi Audio Test CD
 - NTi Audio Minirator for analog systems
 - NTi Audio Digirator for digital or Dolby/DTS systems
- Start the delay test signal.
- Connect the generated delay test signal with an audio cable to the RCA or XLR input of the XL2, e.g. take the reference signal from an auxiliary channel of a mixing console.
- Select XLR or RCA input in the upper XL2 menu
- Set the actual environment temperature, to ensure that the distance is displayed correctly later.

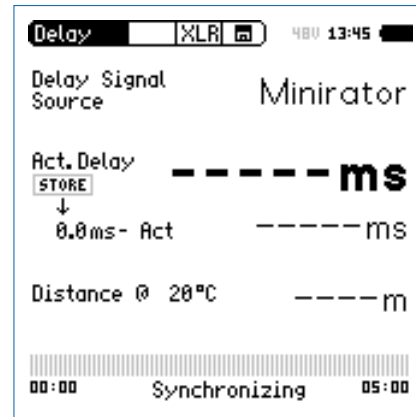

- Wait until the XL2 synchronizes to the incoming delay test signal, then the synchronization time bar fills up.

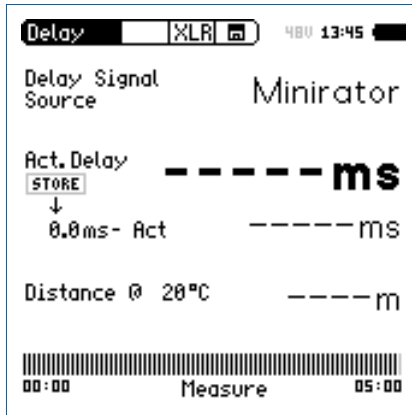

- Disconnect the audio cable, with the synchronizing signal, from the XL2, allowing you to move around freely for the delay measurement. When selecting **Minirator** as the delay signal source, the XL2 has to be synchronized to the signal source again after 5 minutes. When selecting **CD Player** as the delay signal source, the XL2 has to be synchronized to the signal source every 100 seconds.

Measure Reference Speaker A

- Start the delay test signal at speaker A, mute speaker B.
- Position yourself with the XL2 at the measurement position next to speaker B sub left as indicated above. This is the worst-case position in the auditorium with regard to acoustic delay in the sound field. The XL2 uses the VoiceNote microphone for the delay test; do not connect any measurement microphone.

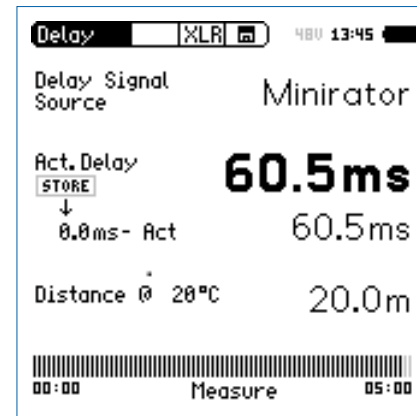

- 👉 The XL2 measures the delay time of speaker A in reference to the electrical input signal in milliseconds.

Store Reference

- Select the displayed **0.0 ms** below **Act. Delay** with the rotary wheel and press enter .

The reference result of speaker A is stored for the difference calculation of delay A - B.

- Stop the delay test signal at speaker A.

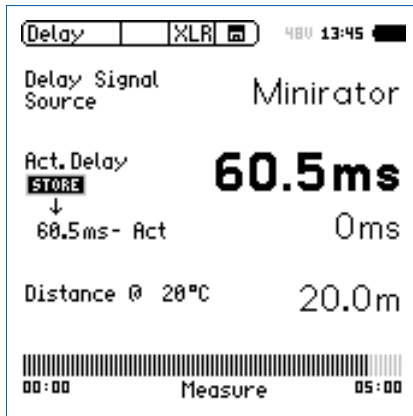

Measure Sub Speaker B

- Start the delay test signal at speaker B. Mute speaker A.
- Position yourself with the XL2 at the shown measurement position. The XL2 uses the VoiceNote microphone for the delay test; do not connect any measurement microphone.

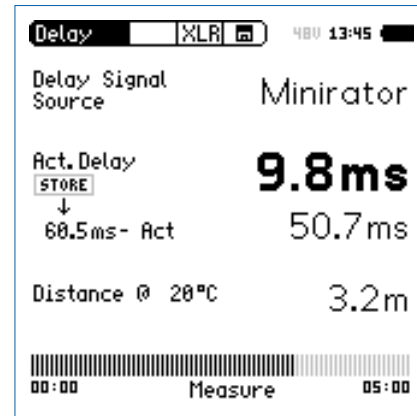



The XL2 measures the delay time of speaker B in reference to the electrical input signal in milliseconds.

Automated Difference Calculation

- The delay time difference between speaker A and B is automatically calculated and shown below the **Act. Delay** result.

 The delay time is measured.

	<p>Delay Test utilizes VoiceNote Microphone The XL2 uses the internal VoiceNote microphone to measure the acoustic delay. Do not connect any measurement microphone to the XL2 for the delay time measurement.</p> <p>Measurement Position Do not position the XL2 too close to reflecting surfaces, such as walls or floors. The reflections are likely to prevent accurate measurements.</p>
---	--

	<p>Result Interpretation</p> <ul style="list-style-type: none"> • The resulting time in milliseconds shows the time difference of the sound signal from speaker A and B arriving at the measurement position. Speaker B has to be delayed by the displayed difference result. • To optimize directionality, add a further 5 ms to the calculated difference. The main signal from speaker A then arrives at the measurement position first. The acoustic signal from sub speaker B arrives 5 ms later. This improves the subjective directionality perception of the listeners. <p>Distance in meter/feet The distance results in meter/feet are displayed below for easy verification of the test results accuracy. The readings are based on 330 m/s sound speed at 0°C / 32°F.</p>
---	---

1/12 Octave + Tolerance (optional)

The Spectral Limits Option extends the XL2 function range with an RTA analyzer with spectral resolutions from 1/1 octave down to 1/12th octave. Trace capturing, relative curve display and comprehensive tolerance handling are supported in the **FFT Analysis** and the high resolution **1/12 Oct + Tol** spectral analysis.

Features:

- High resolution RTA function “1/12 Oct + Tol” with selectable 1/1, 1/3, 1/6 and 1/12 octave spectral resolution
- Captures multiple traces in the internal memory
- Comparing measurement results against captured traces with relative or absolute curve display
- Comprehensive tolerance handling
- Creating tolerance masks based on captured reference curves for passed / failed measurements
- Export and import of tolerance and capture files

Applications

- PA-rental: Verifying the frequency response of returned speakers and microphones against reference records ensuring they are back in stock in good working condition.

- Industrial quality testing: Passed/Failed test in the production line or during service of any audible quality criteria, such as with motors, machines, vacuum cleaners, ...
- Cinema: Comparing frequency responses against an ideal response curve according to the X-Curve requirements.

Tolerance Handling

The XL2 Analyzer compares spectral measurements against a tolerance band and visualizes exceptions in every frequency band. The passed/failed condition is further visualized by the limit button  and forwarded to the I/O interface of the instrument in order to drive an external alarm device such as the accessory SPL Stack Light.

Tolerance curves can either be imported from txt-files or directly derived from captured measurements. The XL2 calculates tolerance bands based on

- Single captured results
- Manually generated txt-files on the PC
- Mean average of multiple captures
- Min/Max curves of multiple captures

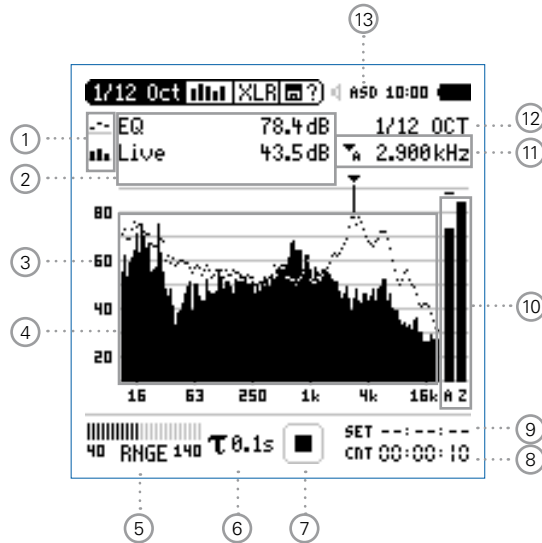

① Result Symbols / Capture & Start Tolerance Mode

This field offers two functions:

- Symbols for measurement results ②

Upper parameter displayed as line.

Lower parameter displayed as bargraph.

- Capture & Start Tolerance Mode

The displayed spectral readings may be captured in C1 - C8 for

- Comparing measurement results against captures with relative or absolute curve display.
- Creating tolerance masks based on captures for passed / failed measurements.

Capture EQ Captures the upper parameter

Capture Live Captures the lower parameter

Manage captures

Allows to rename captures, clear recorded captures, save captures to SD-Card for export from the XL2 or load captures from SD-Card for import to the XL2.

Start tolerance mode

Starts the tolerance mode for passed/failed measurements comparing the actual measurement results against a tolerance band.

② Measurement Result

Actual level result of the indicated frequency band. The cursor readout displays the center frequency and the level of the band indicated by the arrow.







Upper parameter displayed as line.



Lower parameter displayed as bargraph.

③ Y-Scale setting

- Select the Y-Axis with the rotary wheel  and confirm with enter .
- Select the zoom factor between **20, 10, 5, 2.5 dB/div** and confirm with enter .
- Scroll up and down with the rotary wheel  to select the Y-axis range.
- Confirm with enter .

④ Spectral Measurement Result

Spectral results in 1/1, 1/3, 1/6 or 1/12 octave band resolution. Adjust the resolution at .

5 Input Range

The XL2 Analyzer provides three input ranges to accommodate the wide range of input signals. The individual ranges are based on the microphone sensitivity setting in the calibration menu of the XL2. For example at a sensitivity $S=20\text{mV/Pa}$ the input ranges are

- Lower range: 10 - 110 dB SPL
- Middle range: 30 - 130 dB SPL
- Upper range: 50 - 150 dB SPL

Select the lowest possible input range according to the maximum level expected during the measurement; e.g., if the sound pressure will be always below 110 dB SPL, then select the lowest input range 10 - 110 dB SPL.

6 Time Weighting

Offers selectable time weighting of 0.1, 0.2, 0.5 and 1.0 second. Applications:

Short Time Weighting	High resolution in time with minimum averaging
Long Time Weighting	Low resolution in time with longer averaging

7 Run Indication

The run indication shows the measurement status running, paused or stopped. Various measurement settings are locked during ongoing measurements, such as changing the input ranging or the preset measurement time. For passed/failed measurements with the Spectral Limits option the run indication may display **A** for a preset automated level trigger.

8 Actual Measurement Time

Counts actual measurement time in hrs:min:sec. Supports setting of time modes: continuous and single.

Timer Mode Continuous

(applicable for standard measurements)

All values are recorded and monitored continuously after starting a measurement with start . The actual measurement time is shown.

Timer Mode Single

Automatically stops the measurement after the pre-set measurement time.

- Set the required measurement time.
- Start the measurement .

9 Preset Measurement Time

Adjustment of preset measurement time for single timer setting.

10 Broadband Results





User-selectable display of broadband results:

- A** A-weighted broadband sound pressure level
- C** C-weighted broadband sound pressure level
- Z** Broadband sound pressure level without any frequency weighting
- none





11 Readout Frequency

You may select any frequency to read out individual levels. The selected frequency is indicated by the cursor arrow.

Choose between the following settings:

-  The cursor follows automatically the highest level, e.g. tracing feedback frequencies at live sound.
 - Select the frequency with the rotary wheel .
 - Press enter .
 - You may readout any individual frequency.
 - Return to auto frequency with enter .





 The cursor returns to the frequency with highest level bar.

-  The cursor read out may be set manually to any frequency. The read out remains at the selected frequency.
 - Select the frequency with the rotary wheel .
 - Press enter .
 - Select the frequency of interest.
 - Confirm with enter .

 The cursor readout  displays the measurement results of the selected frequency band.

12 Setting of Test Result Resolution

Set the spectral result display to 1/1, 1/3, 1/6 or 1/12 octave band resolution as follows:

- Turn the rotary wheel  to select the parameter 12.
- Press enter  to open the selection window.
- Turn the rotary wheel  to select **1/1 OCT**, **1/3 OCT**, **1/6 OCT** or **1/12 OCT**
- Press enter  to confirm.

13 Phantom Power of Microphone

The XL2 reads the electronic data sheet of any connected ASD microphones provided by NTi Audio and switches the 48V phantom power automatically on as follows:

- Connect the measurement microphone to the XL2.
- Switch on the XL2 .

 The 48V phantom power indication in the upper menu bar changes to ASD. The **XL2** is ready for acoustic measurements.

1/12 Octave - Getting Started

Test Preparations

The XL2 reads the electronic data sheet of any connected ASD microphones provided by NTi Audio and switches the 48V phantom power automatically on as follows:

- Connect the measurement microphone to the XL2.
- Switch on the XL2 .

 The **48V** phantom power indication in the upper menu bar changes to **ASD**. The XL2 is ready for acoustic measurements.

- Position the XL2 at the measurement location using a microphone stand or tripod.
- Select the **1/12 Oct + Tol** function in the measurement menu.



The displayed wideband and spectral levels are measured and stored simultaneously.

Configuration

The XL2 displays two different sound pressure levels at the same time. You configure to display either the levels **Live**, **Max**, **Min**, **EQ** or captured results.

- Select the upper result parameter with the rotary wheel .

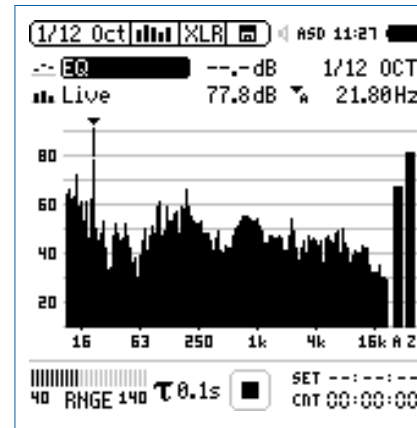

- Confirm with enter .

Select Upper/Lower Reading

👉 The pop-up window **Select reading** shows up.

- Select the time-averaged sound level **EQ**. All available selections are Z-weighted (= no weighting).

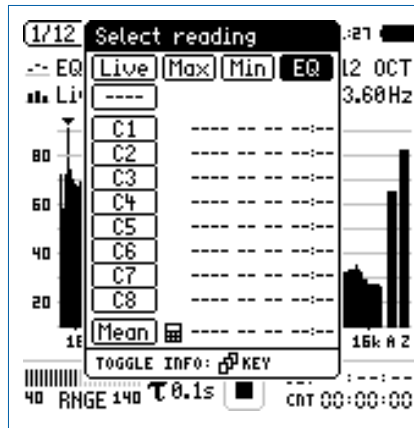

- Confirm with enter

👉 The pop-up window **Select reading mode** shows up.

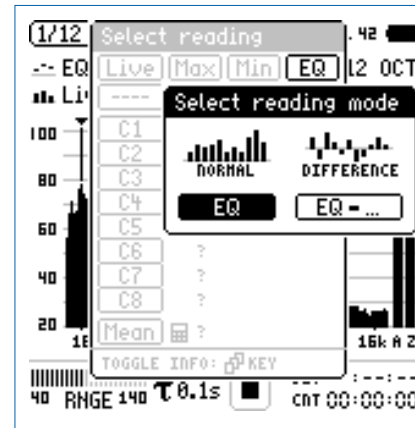

- Select **EQ** for normal absolute display of measurements.
- Follow the same instruction and select the lower spectral reading **Live**.



Press start to measure and display the sound levels results indicated with ----.

Select Input Range

Select the lowest possible input range according to the maximum level expected during the measurement.

- Select the input range **RNGE** and press enter
- Turn the rotary wheel to set the applicable input range and confirm with enter .

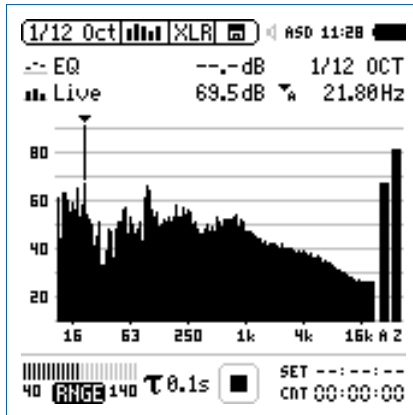

Start and Stop the Measurement

- The XL2 measures the selected sound pressure levels **Live** and **EQ**. All available sound levels are Z-weighted (= no weighting).
- Press start .

The run indication switches to running . The actual sound level Live and the averaged level EQ are displayed. The parameter **RUN** flashes in the memory menu.

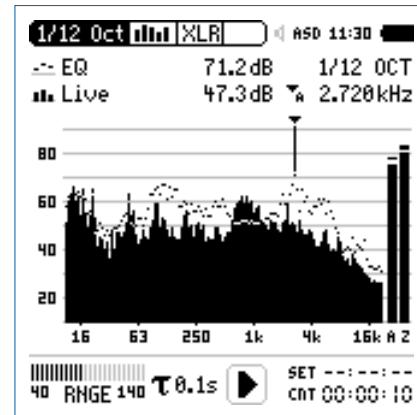



- Press the stop button to stop the measurement.

Save the Measurement Result

- Select the memory menu  with the rotary wheel  and confirm with enter .

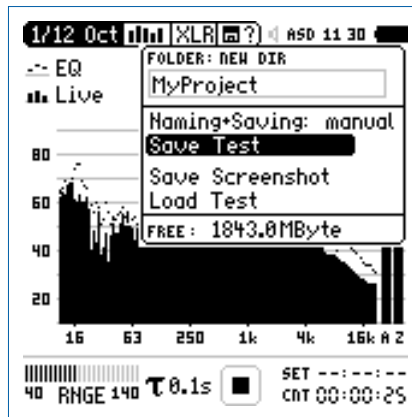
 The memory menu opens.



- Press enter  to store the test results as an ASCII-file or select **Save Screenshot** to store the screenshot.

 The measurement is completed.

Capture References and Create Tolerances

The Spectral Limits Option extends the function range of the XL2 with trace capturing, relative curve display and comprehensive tolerance handling for the **FFT** Analysis and the high resolution **1/12 Oct + Tol** spectral analysis.

Features:

- Capturing of multiple readings into the internal memory
- Comparing measurement results against captures with relative or absolute curve display
- Comprehensive tolerance handling
- Creating tolerance masks based on captures for passed / failed measurements
- Export and import of tolerance and capture files
- True peak level in 1/1 and 1/3 octave resolution
- High-resolution Zoom-FFT up to 0.4 Hz steps in the frequency range 5 Hz - 20 kHz

Read the detailed description in the separate chapter "Spectral Limits Option (Capture + Tolerances)" in this manual.

Speech Intelligibility STI-PA (optional)

The STI-PA analyzer option allows reliable measurement of the speech transmission index within 15 seconds. Besides the single value STI or CIS test result, a detailed view of the modulation indices and individual band level results is provided. The STI-PA analyzer meets the latest 2003 IEC 60268-16 standard.

The speech intelligibility depends on the following system parameters:

- Frequency response
- Reverberation time RT60
- Distortion
- Signal-to-noise ratio
- Sound pressure level
- Reflections
- Psychoacoustic effects (masking effects)

The speech intelligibility measurement STI-PA is an option for the XL2 Audio and Acoustic Analyzer. Ask the local representative for purchasing details.

STI-PA Signal Source

NTi Audio TalkBox	<p>The NTi Audio TalkBox simulates a person talking at a precise acoustic level, enabling the measurement of the complete signal chain including the microphone</p> <ul style="list-style-type: none">• Place the NTi Audio TalkBox in front of the microphone at the typical position of the talking persons head.• Select Track 1 for the STI-PA test signal.• Select Output Mode to Speaker; you should hear the STI-PA test signal.
Minirator MR-PRO	<p>The Minirator MR-PRO is used for electrical signal injection into public address systems that commonly use alarm messages from a hard drive (systems without a microphone).</p>
CD Player	<p>The NTi Audio CD “STI-PA V1.1” included in the package, can be used with a professional CD player. For details see the chapter “STI-PA Measurement Hints”</p>

STI-PA Numeric Result Page

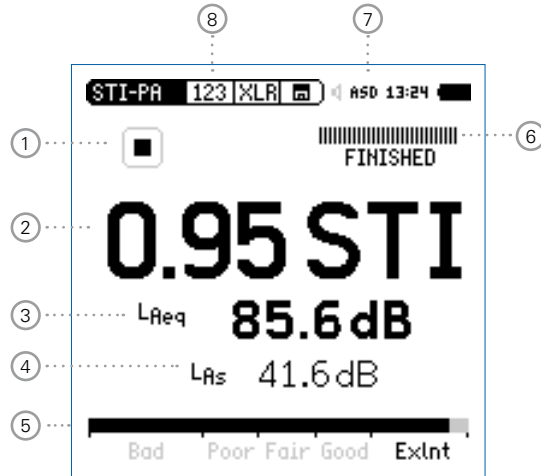

STI-PA Table Result Page

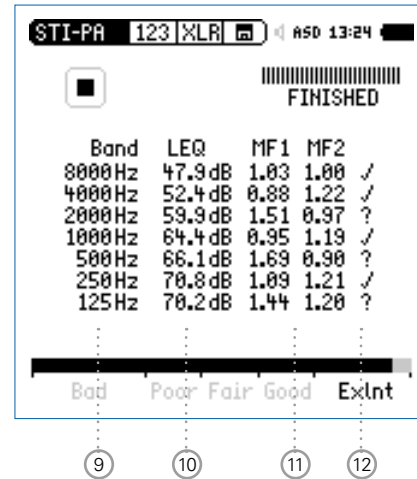

① Run Indication

This icon displays the run status of the STI-PA measurement.

② STI-PA Measurement Result

Single value speech transmission index result in STI (Speech Transmission Index) or CIS (Common Intelligibility Scale), whereby CIS is calculated as $CIS = 1 + \log STI$.

③ Sound Level L_{Aeq}

Shows the time-averaged sound level of the 15 seconds STI-PA measurement cycle time.

④ Sound Level L_{AS}

Shows the actual sound pressure level, including A-weighting and slow time weighting in accordance with IEC 60268-16.

⑤ Analog STI-PA Bargraph

Bargraph display and interpretation of the speech intelligibility measurement result

- Bad 0.00 - 0.30 STI
- Poor 0.30 - 0.45 STI
- Fair 0.45 - 0.60 STI
- Good 0.60 - 0.75 STI
- ExInt 0.75 - 1.00 STI

⑥ Progress Bar

Measurement status indication; the single STI-PA measurement takes 15 seconds. The actual measurement time and measurement status are indicated here.

⑦ Phantom Power of Microphone

The XL2 reads the electronic data sheet of any connected ASD microphones provided by NTi Audio and switches the 48V phantom power automatically on as follows:

- Connect the measurement microphone to the XL2.
- Switch on the XL2 .

 The 48V phantom power indication in the upper menu bar changes to ASD. The **XL2** is ready for acoustic measurements.

⑧ Page Selector STI-PA

Select between the available result pages:

 STI-PA numeric result page

 STI-PA table result page, detailed results per octave band

The page button  toggles between these displays.

9 STI-PA Octave Bands

Frequencies 125 Hz - 8 kHz in 1/1 octave band resolution.

10 Sound Pressure Level L_{eq}

Individual time-averaged octave band level L_{eq} .

11 STI-PA Modulation Index MF1, MF2

For good speech intelligibility it is mandatory that the integrity of the transmitted voice signal modulations are preserved. Therefore STI-PA is based on measuring the MTF (Modulation Transfer Function). This function quantifies the degree to which the voice modulations are preserved in individual octave bands. STI-PA determines the MTF by analyzing the seven frequency bands. Each band is modulated with two frequencies, resulting in the modulation index 1 and index 2. These two indexes combined give the single-value STI-PA result.

12 Error Detection

The STI-PA measurement function has a built in error detection which helps you identifying faulty measurements. The error detection checks the following parameters:

- Invalid modulation indices (MF1 or MF2 > 1.3)
- Irregularities during ongoing measurements

Both parameters depend on the amount of impulsive environmental noise, which influences the accuracy of any STI-PA measurement.

The STI-PA numeric result page displays the measurement result interrupted by the flashing “?.??” question marks if the error detection finds any problem. Furthermore, octave band results detected with irregularities are marked in the STI-PA table result page with a question mark (?). The error indication might be caused by either

- Missing test signal level or
- Impulsive background noise events

If the error detection finds any faults, you should repeat the measurement and compare the STI-PA test result with the previous ones.

STI-PA Measurement - Getting Started

Test Preparations

The XL2 reads the electronic data sheet of the connected NTi Audio measurement microphone and switches the 48V phantom power automatically on as follows:

- Connect the NTi Audio measurement microphone to the XL2 Analyzer.
- Switch on the XL2 .

 The 48V phantom power indication in the upper menu bar changes to ASD. The **XL2** is ready for acoustic measurements.

- Position the XL2 at the measurement location using a microphone stand or tripod.
- Select the **STI-PA** measurement function in the measurement menu and toggle with page  to the STI-PA numeric result page.
- Prepare the environment for the measurement. For example mute all sound sources to establish silence.



Preconditions for STI-PA measurement:

- No impulsive noise events should occur during the 15 seconds measurement time. Even noise with relatively moderate levels may affect the STI-PA test result.
- To avoid measurement failures the STI-PA signal level L_{eq} should be minimum 60 dB SPL in the measured area.
- The STI-PA measurement should be carried out in an environment simulating emergency conditions (same sound pressure level and all components activated).
- During the measurement no speaking or other noise sources should be allowed near the measurement microphone.

Measure Environment Noise

- Verify the actual sound pressure level of the environment as shown on the XL2 display.
- Mute all disturbing noise.



Start STI-PA Test Signal

- Switch on the STI-PA test signal at the signal source.
- Set the acoustic sound pressure level of the PA system to simulate a typical emergency condition situation; e.g., LA_s = 85 dB.



Start STI-PA Measurement

- Press start

👉 The progress bar switches to **RUNNING**. The test result tendency is shown on the STI-PA bargraph, marked with **Bad**, **Poor**, **Fair**, **Good** and **ExInt**.





Stop STI-PA Measurement

After the period of 15 seconds the STI-PA measurement finishes automatically. The progress bar indications switches to **FINISHED** and the final STI-PA test result is displayed.

- Switch off the STI-PA test signal at the signal source.



Store STI-PA Measurement Result

- To store the test result, select the memory menu  with the rotary wheel  and press enter .
- Select **Save Test** to store the test results as an ASCII-file or select **Screenshot** to store the screenshot.



The detailed STI-PA test result view of the modulation indices and individual band level results is provided on the second STI-PA measurement page. Use the page selector or press page  to access.

 The speech intelligibility STI-PA is measured and the results are stored on the SD Card.

STI-PA Post-Processing

Measuring the speech intelligibility index under realistic environmental conditions is often not feasible; e.g., playing the test signal in a railway station at emergency levels during peak hours will irritate passengers. Additionally, at rush-hour the characteristics of background noise might be highly impulsive, while a pre-requisite for accurate STI-PA measurements is a negligible impulsivity in the background noise.

Under such circumstances the STI-PA measurement should be shifted to a more suitable time of the day; e.g., night time. Such STI-PA measurements taken with untypical background noise conditions have to be post-processed. Post-processing combines the STI-PA measurement data taken at quasi noise-free ambient conditions with the unweighted time-averaged octave band noise levels (Leq) taken with realistic environmental conditions; e.g., day time.

The NTi Audio STI-PA Post-Processing Software is tailored for this application by combining the night and day-time measurement.

“NTi_Audio_STI-PA_PostProcessing.xlt” is a free download for all registered XL2 customers on the support website at <http://my.nti-audio.com>. (Enable all macros when opening the document.)

STI-PA Measurement Hints

- Any background noise has to be sufficiently static during the measurement. Pink noise fulfills this requirement.
- Verify the environmental conditions prior to testing by performing STI-PA measurements without any test signal. The results should be < 0.20 STI.
- Impulsive background noise during the measurement, such as speech, causes severe measurement errors. The STI-PA result is usually too high.
- In case such impulsive noise cannot be prevented, consider taking the measurements at another time (e.g., night time) and afterwards correcting with the averaged daily background noise, using external post-processing.
- Only high-quality CD-Players should be used to reproduce the STI-PA test signal as only limited time-shifts (± 200 ppm) ensure reliable STI-PA test results. Pitch control and shock protection should be disabled. We recommend that only professional CD-Players be used. Verify the time shift of the CD-Player with a 1 kHz test signal:
 - Insert the NTi Audio Test CD into the CD-Player and start track 1, which is the 1 kHz test signal.
 - Connect the XL2 directly to the audio output and measure the signal frequency in RMS/THD+N mode. The displayed frequency should be in the range from 0.9998 kHz to 1.0002 kHz
- STI-PA test signals from other test system manufacturers may sound similar but are not compatible. Only the NTi Audio STI-PA test signal CD V1.1 or higher should be used in combination with the XL2.
- STI-PA measurement of alarm systems should be carried out in simulated emergency conditions (same sound pressure level and all components activated).
- At locations with varying conditions (e.g., some public areas with few people and other areas with crowds) the worst-case STI-PA results should be measured. Consult the local regulations (e.g., the NFPA code in the U.S.) for directives concerning measurement locations and number of required STI-PA measurements under which circumstances.
- Select typical locations based upon such regulations, or typically position the microphone at 1 - 1.2 meters above ground in sitting areas or 1.5 - 1.8 meters in standing areas (typical positions are not directly in front of the speakers).
- The person taking the measurements should be out of the acoustic field, so as not to affect the measurement results. For this purpose the measurement microphone can be mounted on a microphone stand and connected with the ASD-Cable to the XL2.
- Low STI-PA readings can be caused by
 - Excessive sound reverberation, echoes or reflections
 - Poor speaker directivity or speaker coverage
 - Speaker power setting incorrect; e.g. low signal-to-noise ratio.

6. Audio Analyzer

Besides the comprehensive sound level meter and acoustic measurement functions, the XL2 Audio and Acoustic Analyzer also offers the analog audio measurement functions **RMS/THD+N** and **Oscilloscope**.

RMS/THD+N

The XL2 Audio and Acoustic Analyzer measures the parameters Level RMS, THD+N and frequency simultaneously.

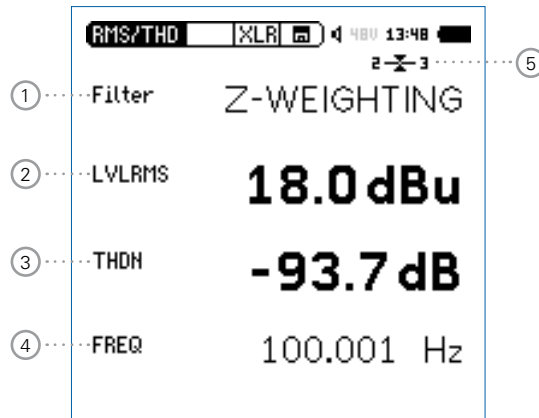

① Filter

Z-Weighting Frequency Z-weighting with flat frequency response from 20 Hz to 22 kHz. Default measurement setting.

A-Weighting Frequency A-weighting according IEC 61672 for low noise levels.

C-Weighting Frequency C-weighting according IEC 61672 for high noise levels.

HP 100Hz Highpass 100 Hz, -200 dB/dec., maximally flat magnitude filter, e.g. -60 dB @ 50 Hz

HP 400Hz Highpass 400 Hz, -120 dB/dec., maximally flat magnitude filter, attenuates 50/60Hz components of test signal

HP 19k Highpass 19 kHz; e.g., to measure a 20 kHz pilot tone level of a public address system without disturbing the public.

22.4 - 22.4k Bandpass filter 22.4 Hz - 22.4 kHz (IEC 468-4)

② Level RMS

Measures the absolute level of the input signal. The unit's dBu, dBV, V and dB SPL are selectable.

③ THD+N

Measures the total harmonic distortion and noise of the input signal. The distortion measurement, expressed in dB, linear or in %, is conducted within the bandwidth 10 Hz - 20 kHz.

④ Frequency in Hz

The XL2 automatically extracts and measures the frequency of the fundamental signal. The XL2 frequency counter technology even reads the frequency correctly for heavily distorted signals.

⑤ Balance Indicator

Indication of the audio signal balance between pin 2 and 3 on the XLR input for input signals > -34 dBu.



The input signal is balanced.



The signal is unbalanced. The level at pin 2 is higher than at pin 3.



The signal is unbalanced. The level at pin 3 is higher than at pin 2.

PreNotch Listening

The input signal is audible at the rear speaker or headphone output.

- Press and hold down the speaker button

The pop-up window volume is displayed.

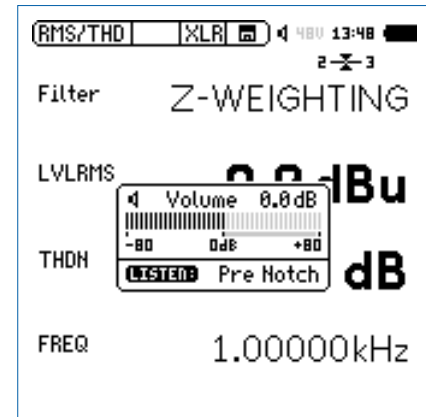

PostNotch Listening

The main frequency component is filtered out by a notch filter, leaving only the remaining signal audible.

- Press the speaker button to display the volume window.
- Additionally press enter .

The post notch listening with auto-gain function is activated. The maximum gain setting is 0 dB.



e.g. using a 100 Hz sine test signal connected to the XL2 input, with the 100 Hz main frequency filtered by the notch filter, the complete frequency spectrum is available at the speaker or headphone output. This feature allows you to listen to the actual distortion signal. You therefore hear a noise from the speaker even without any connected inputs signal!

Oscilloscope

The scope function visualizes the waveform of the electrical input signal. It automatically triggers to the fundamental frequency and selects the scaling of the X-axis (time) and Y-axis (level) accordingly. The fundamental, or most dominant, frequency of the input signals is displayed above the scope screen.

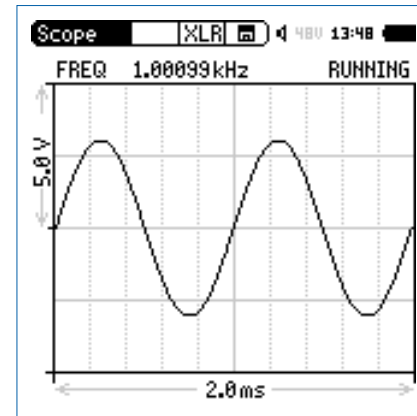

The scope scaling is fixed.

7. Calibration

The XL2 Audio and Acoustic Analyzer meets or exceeds the specifications listed in the chapter “Technical Data”.

Instrument Calibration

In order to maintain the high accuracy, annual calibration of the XL2 Analyzer and the measurement microphone is recommended. The calibration service verifies the complete product specifications, differences to the last calibration and measures the frequency response of the measurement microphone. To enquire about calibration service, follow the RMA guide lines at www.nti-audio.com.

Microphone Sensitivity

NTi Audio’s ASD measurement microphones and the microphone pre-amplifier MA220 include an electronic data sheet. The Automated Sensor Detection (ASD) of the XL2 recognizes the sensitivity and calibration data of the connected microphone. The electronic data sheet, including the microphone sensitivity, is displayed in the menu **Calibrte**.

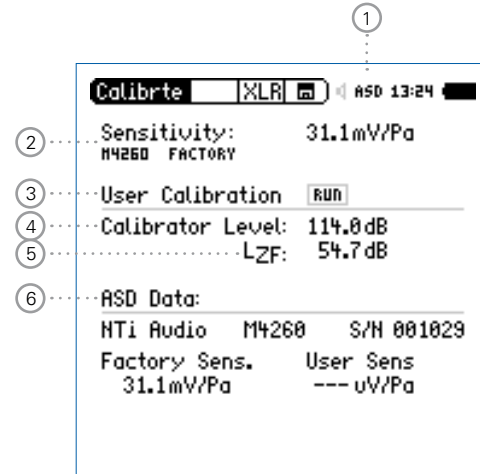

① Phantom Power of Microphone

The XL2 reads the electronic data sheet of any connected ASD microphones provided by NTi Audio and switches the 48V phantom power automatically on as follows:

- Connect the measurement microphone to the XL2.
- Switch on the XL2 .

 The **48V** phantom power indication in the upper menu bar changes to **ASD**. The XL2 is ready for acoustic measurements.

② Factory Sensitivity

Factory sensitivity of measurement microphone in mV/Pa. The sensor detection of the XL2 reads the sensitivity automatically from the electronic datasheet of the connected NTi Audio measurement microphone or microphone pre-amplifier.

③ User Calibration

Sensitivity setting with an external calibrator.

④ Level of External Calibrator

Level setting of an external calibrator.

⑤ Level Type

LZF Default setting.







LHP100F Suppressing any low frequency noise, for example wind during outdoor calibrations.

⑥ Electronic Data Sheet of Measurement Microphone

Read out data from the connected microphone.

User Calibration - With External Precision Calibrator





User-sensitivity setting for measurement microphones with an external calibrator.

- Turn the rotary wheel  to select the parameter **Calibration Level**  and press enter .
- Set the calibration level according to the calibrator used.
- Generate the specific reference signal with the calibrator onto the microphone.
- Turn the rotary wheel  to select the parameter **RUN** next to **User Calibration**  and press enter .
- The pop-up window **Calibration: Calibration running ...** shows up and changes to **Calibration: Successfully finished!** for a successfully completed calibration.

 The user calibration with an external calibrator is completed.

User Calibration - Manual Sensitivity Setting

In case no external calibration device is available, set the sensitivity of non-NTi Audio microphones manually according to the product specifications as follows:

- Select **Sensitivity**  with the rotary wheel .
- Press enter  and adjust the sensitivity with the rotary wheel  in 0.1 mV/Pa steps. The setting range 100 $\mu\text{V}/\text{Pa}$ - 9.99 V/Pa is supported.
- Confirm with enter .

 The manual user calibration is completed.



User Sensitivity

The XL2 writes the user-sensitivity setting onto the electronic data sheet of the connected NTi Audio measurement microphone or microphone preamplifier. All subsequent measurements automatically utilize this user-sensitivity.

8. Profiles

Profiles are templates of measurement setups. You may define which profile is loaded at startup, so that the measurements are carried out always with the same setup and instrument settings.

A remarkable advantage of the XL2 is the flexible user interface. The measurement screens may be personalized and only a limited subset of the comprehensive functionality enabled to create simplified operator interfaces. Advanced users may access all menus, settings and store their preferred measurement configurations. For simplicity the XL2 Audio and Acoustic Analyzer offers fixed operator interfaces with specific pre-defined settings. The XL2 can boot up with exactly the required measurement parameters according to the pre-defined instrument configurations. This ensures accurate measurements are achieved in both advanced and basic usage environments.

Profiles - Getting Started

Activate Profile Selection at Startup

- Select **Show profile list** ① in the **System** menu.
- Press enter ↵ to activate **Yes**. This will show the profile list at startup.

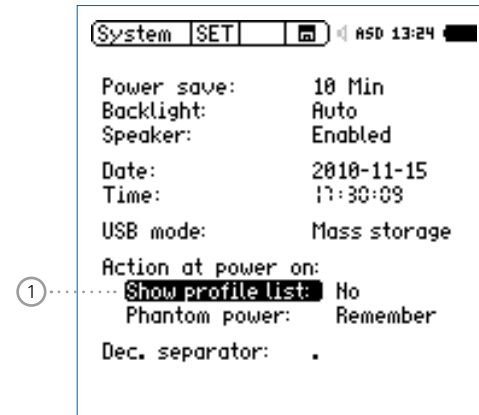

👉 The profile list is shown next time you power up the XL2.

Preset Measurement Function

- Start the XL2 Analyzer in **Full mode**.
- Select the typically-used measurement function and adjust the measurement parameters according to the requirements.

For example, measuring the sound levels L_{AF} , L_{Aeq} and L_{AFmax} for 10 seconds:

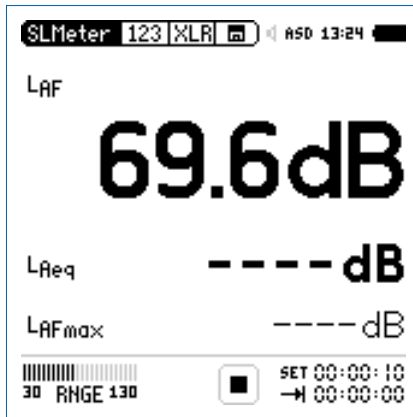

Store MyFirstProfile

- Select **Profile** in the main menu and press enter

The profile menu opens.

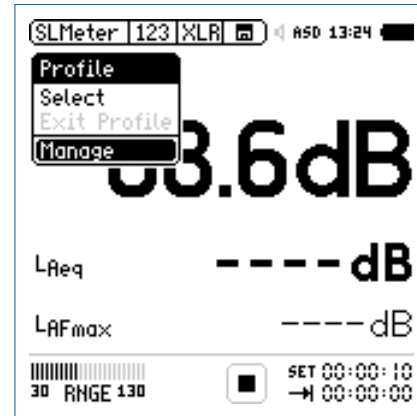

- Select **Manage** and press enter (↵).

👉 The **Manage Profile** menu opens.



- Select **Save Profile** and press enter (↵).

👉 The **Save Profile** menu opens.



Each stored profile includes all settings of all measurement functions and pages. Only the following details are not stored:

- Calibration settings
- System settings
- Temperature unit
- Phantom power on/off

- Select **Rename** and press enter (↵).
- Set the profile name to **MyFirstProfile**. The maximum name length is 20 characters.

- Select **Configure available screens** and press enter ↵.



- Select additional available pages/measurement functions for the profile; e.g., RTA
- Press escape to return to the **Save Profile** screen.
- Set **Append mode available: yes** in order to have the append data feature available in the memory menu .
- Select **Save** and press enter ↵.

MyFirstProfile is saved in the internal XL2 memory.

Select Profile at Startup

- Switch on the XL2 .

The profile selection is shown on the display.

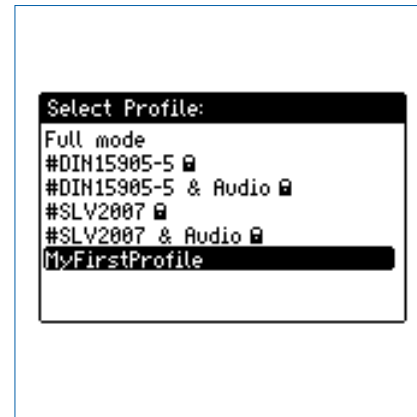

- Select the profile **MyFirstProfile** and press enter ↵.

The XL2 starts up with the pre-configured settings for sound level monitoring.

Select Profile during Operation

- Select **Profile** in the main menu and press enter .

 The profile menu opens.

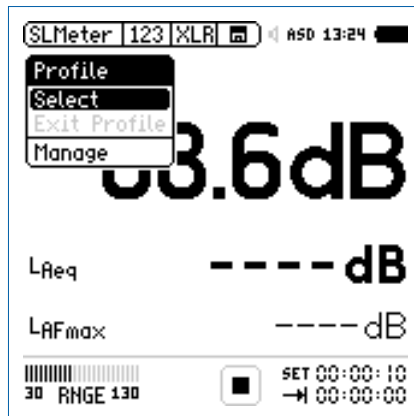



- Choose **Select** and load the required profile.

Run Measurement

The profile name is displayed when a measurement function is highlighted. The main menu offers only the measurement functions enabled by the profile, plus the calibration and profile menu.

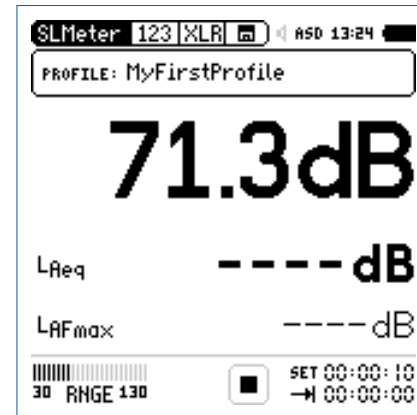
- Press start .



- Wait 10 seconds until the measurement is finished.
- To return to the full mode either switch off the XL2  again or select **EXIT Profile** in the main menu.

Export MyFirstProfile to PC

If you have two or more XL2 Audio and Acoustic Analyzers, you may like to transfer the same profiles to the other instruments.

- Select **Profile** in the main menu and press enter (↵).
- Select **Manage** and press enter (↵).
- Select **Export to SD-Card** and press enter (↵).

👉 The XL2 generates a folder on the SD Card called “Profiles”. All available profiles are exported into this folder.

- Connect the XL2 to the PC.
- Copy/paste the profile called **MyFirstProfile** to the PC.

Import MyFirstProfile from PC

- Connect another XL2 to the PC and generate a folder called “Profiles” on the SD Card.
- Copy the profile called **MyFirstProfile** into the folder “Profiles”.
- Start up the XL2, select **Profile** in the main menu and press enter (↵).
- Select **Manage** and press enter (↵).
- Select **Import from SD-Card** and press enter (↵).

👉 **MyFirstProfile** is available on the other XL2 Analyzer.



If the profile is exported from an XL2 Analyzer with activated options to another XL2 Analyzer without options, then these options have to be hidden prior to storing the profile for export:

- In the exporting XL2 system menu, select the individual option and toggle with enter (↵) to **Hidden**.
- Store the profile in the XL2 Analyzer.

The XL2 can store up to 20 individual profiles in the internal system memory and offers three different profile types:

Types	Description
Factory default profiles	<p>The XL2 includes factory default profiles, which are marked with “#” in the beginning of the file name. Sample filename: #DIN15905-5.prf</p> <p>The factory default profiles are a free download for all registered XL2 customers on the support website at http://my.nti-audio.com. For details see the chapter “Registration” in this manual.</p> <p>For detailed settings of factory default profiles please see the Appendix 2 in this manual.</p>
User profiles	<p>User profiles are profiles generated by you on the XL2 Analyzer. Sample filename: MyFirstProfile.prf</p>

Secured profiles

Secured profiles are locked user profiles with overwrite protection indicated by the file name ending in “xxx.prf\$”. This file name can not be overwritten.

Sample filename: MyFirstProfile.prf\$

How to generate secured profiles

- Export the profiles to SD Card according to the procedure in the chapter “Profile - Getting Started”.
- Connect the XL2 to the PC.
- Select the user profile in the folder “Profile”.
- Manually change the ending of the user profile from “xxx.prf” to “xxx.prf\$”
- Disconnect the XL2 from the PC.
- Import the profiles from the SD Card
- Power off/on  the XL2 Analyzer

 The secured profile is displayed with a lock-symbol in the profile selection window on startup of the XL2.

9. Spectral Limits Option (Capture + Tolerances)

The Spectral Limits Option extends the function range of the XL2 with trace capturing, relative curve display and comprehensive tolerance handling for the **FFT** Analysis and the high resolution **1/12 Oct + Tol** spectral analysis.

Features:

- Capturing of multiple readings into the internal memory
- Comparing measurement results against captures with relative or absolute curve display
- Comprehensive tolerance handling
- Creating tolerance masks based on captures for passed / failed measurements

Capture the EQ Measurement Results

- Select the Capture & Start Tolerance Mode symbol for capturing the measurement result.

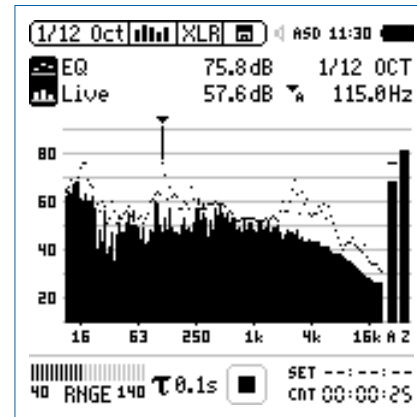

- Confirm with enter ↵.

👉 A pop-up window shows up.

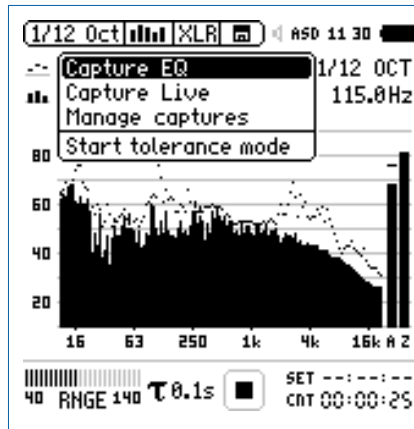

- Select **Capture EQ**.
- Confirm with enter ↵.

👉 The pop-up window ... **and store it to** shows up.

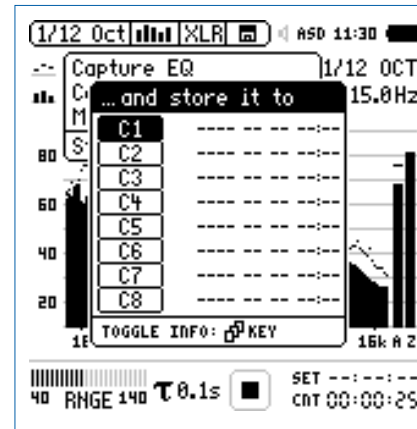

- Select **C1**.
- Confirm with enter ↵ and set the capture name in the displayed letter selection box e.g. to **Ref**.

👉 The capture has been stored in the internal XL2 memory.

Edit Capture Manually

- Select the Capture & Start Tolerance Mode symbol.
- Confirm with enter ↵.
- Select **Manage captures**.
- Confirm with enter ↵.
- Select **Save to SD card**.

👍 The pop-up window **Save captures** shows up.

- Select the capture to be exported, e.g. **C1**.

👍 The pop-up window **Save capture C1 to** shows up.

- Confirm with **Save**.

👍 The XL2 generates the file MyCapture.txt in a new folder called Captures.

- Edit the sound level data in the capture file. You may delete any unused frequencies. All remaining frequency data has to remain the same. Any frequency changes will be discarded by the xL2.
- Load the new capture file with **Manage captures** back into the internal XL2 memory.

Compare the Live Level against Capture

- Blank the upper parameter by setting ----.
- Select the lower parameter with the rotary wheel ⌚.
- Confirm with enter ↵.
- Select **Live** and confirm with enter ↵.

👍 The pop-up window **Select reading mode** shows up.

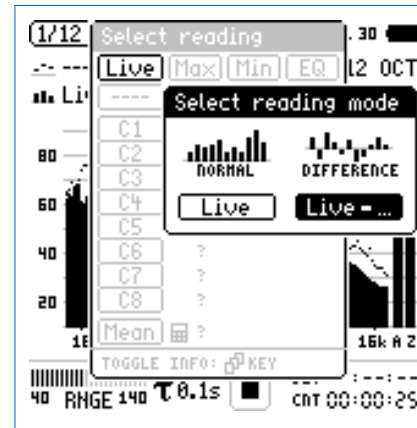

- Select **Live -** for displaying the relative difference.
- Confirm with enter ↵.
- Select **Ref** and confirm with enter ↵.
- Set the Y-axis accordingly to show the zero-line.

👉 The relative difference of the Live level compared to the captured reference is displayed.

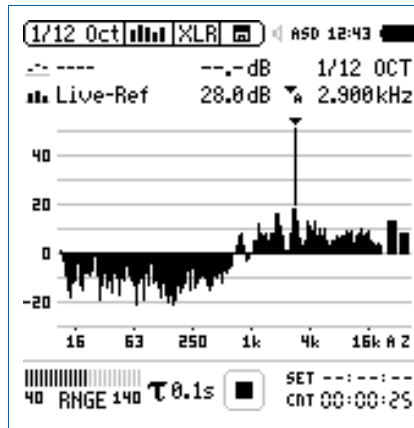

Start Tolerance Mode for Passed/Failed Measurements

- Select the Capture & Start Tolerance Mode symbol with the rotary wheel 🔄.

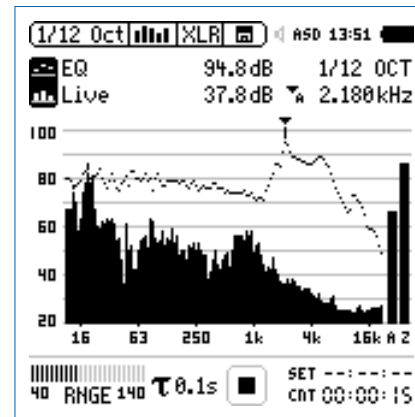

- Confirm with enter ↵.

👉 A pop-up window shows up.

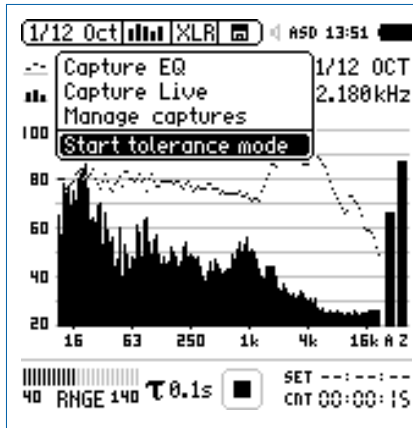

- Select **Start tolerance mode**.
- Confirm with enter (↵).

👉 The pop-up window **Make tolerance from** shows up.

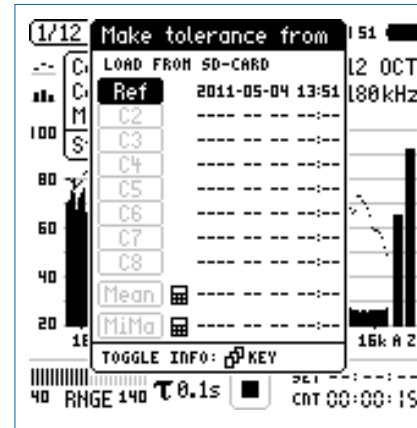

- Select **Ref** to load the earlier captured reference spectrum.
- Confirm with enter (↵).



You may press the page button [PAGE] to toggle between the date and spectral resolution data of the capture.

Passed Result

👍 The tolerance mode is active for passed/failed measurements.

The passed/failed condition is further visualized by the bicolor “limit” button and forwarded to the I/O interface of the instrument in order to drive an external alarm device such the accessory SPL Stack Light.

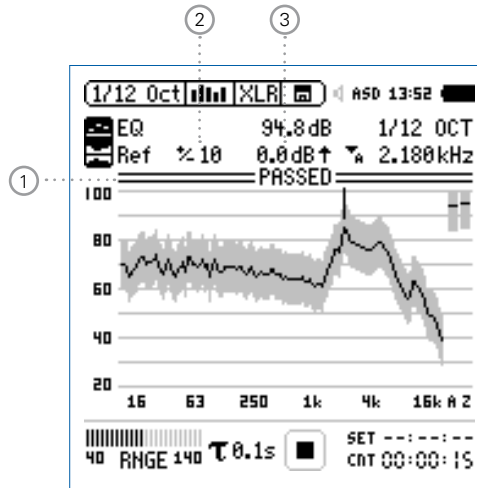

① PASSED / Failed Result

PASSED The actual measurement result is within the tolerance band.



The actual measurement result is outside of the tolerance band. Exceptions are visualized in any out-of-tolerance frequency band.

② Tolerance Bandwidth

Adjusts the tolerance bandwidth based on the captured reference spectrum in dB.

③ Level Offset

Provides a level offset in dB to move the tolerance band up/down.

Failed Result

The XL2 Analyzer compares spectral measurements against a tolerance band and visualizes exceptions ① in every frequency band.

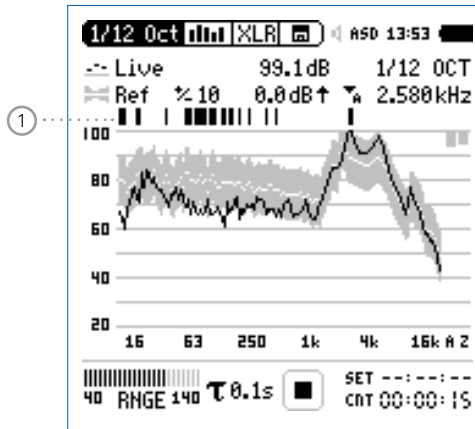

Select another Tolerance File

- Select the tolerance **Ref** with the rotary wheel
- Confirm with enter
- Select the new tolerance file from the SD Card or the internal XL2 memory.

Exit Tolerance Mode

- Select the Capture & Start Tolerance Mode symbol to exit from the tolerance mode.

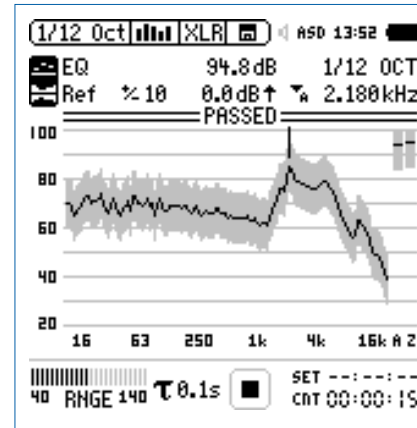

- Confirm with enter
- Select **Exit tolerance mode**.
- Confirm with enter

Advanced Start Functions

You may start the passed/failed measurement by one of the following possibilities:

- Press the XL2 start button .
- Activate the automated level trigger in the tolerance file.
- Activate the digital input 1 via the external I/O interface; e.g. a foot switch or a PLC control.

Tolerance Management

Tolerance curves can either be imported from txt-files or directly derived from captured measurements. The XL2 calculates tolerance bands based on

- Single captured results
- Manually generated txt-files on the PC
- Mean average of multiple captures
- Min/Max curves of multiple captures

Create Tolerance Files Manually on PC

- Capture a spectrum on the XL2 Analyzer.
- Enter the tolerance mode and generate a tolerance band for the capture.
- Select the Capture & Start Tolerance Mode symbol.
- Confirm with enter .
- Select **Save tol. to SD Card** to export the capture tolerance

file. This file includes the reference capture and the tolerance data. The XL2 generates a txt-file in the folder "Tolerances".

- Open the capture tolerance file with a text editor or MS Excel.
- Edit the tolerance data according your requirements. You may delete any unused frequencies. All remaining frequency data has to remain the same. Any frequency changes will be discarded by the xL2.
- Store your individual tolerance file as txt-file in the XL2 folder "Tolerances".
- Start the XL2 tolerance mode and load the new tolerance file from the SD Card.



- All entries in the customized tolerance file need to be tab-separated.
- The individual tolerance file entries may be in any order; no sequential order required.
- Tolerance file templates and standardized tolerance files are a free download for all registered XL2 customers on the support website at <http://my.nti-audio.com>. For details see the chapter "Registration" in this manual.

```

#Unit
dBr

#Mode
HighLow

#Columns
Frequency  Min          Ideal   Max

#ATolerances
UNDEF          80   undef   90

#ZTolerances
UNDEF          80   undef   90

#BandTolerances

|       |    |       |    |
|-------|----|-------|----|
| 20    | 70 | undef | 80 |
| 1000  | 70 | undef | 80 |
| 1000  | 73 | undef | 77 |
| 4000  | 73 | undef | 77 |
| 4000  | 70 | undef | 80 |
| 20000 | 70 | undef | 80 |



#LevelOffset
0

#HideUnusedBands
false

#nAllowedViolations
0

```

#Unit

dBr (relative), fixed setting

#Mode

Describes tolerance type; the XL2 allows setting of the tolerance type independently of the tolerance file.

HighLow

Utilizes upper and lower tolerance based on ideal reference.

High

Utilizes only upper tolerance based on ideal reference.

Low

Utilizes only lower tolerance based on ideal reference.

#Columns

Column headings for further tolerance data separated in different columns: Frequency - Min - Ideal - Max

#ATolerances

Defines the tolerance band for the A-weighted wideband level (not mandatory).

#CTolerances

Defines the tolerance band for the C-weighted wideband level (not mandatory).

#ZTolerances Defines the tolerance band for the Z-weighted wideband level (not mandatory).

- #Band Tolerances**
- Defines the tolerance band for the individual frequencies.
 - The ideal parameter can be set as “undef”.
 - The same frequency value on two successive rows defines a tolerance step, e.g.:

Frequency	Min	Ideal	Max
100	70	75	80
500	70	75	80
500	75	80	90
1000	75	80	90

#LevelOffset All levels in the tolerance file are relative levels dBr. Thus the level offset provides the relation between the relative level and actual sound pressure level. (not mandatory)
The XL2 allows setting of the level offset independently of the tolerance file.

#Hide UnusedBands This parameter defines which tolerance frequency range is shown. (not mandatory)

True Measurement results of frequency bands without any specified tolerance are not displayed.

False The measurement result of all frequency bands are shown.

#nAllowed Violations Allows a **PASSED** result with a maximum number of n failed frequency bands (not mandatory)

#FreqScale Spacing

Defines the frequency scale spacing in the X-axis for the tolerance data. (not mandatory)

lin Tolerance data displayed with linear frequency spacing, e.g. used in the **FFT** function. (default setting)

log Tolerance data displayed with logarithmic frequency spacing e.g. used in the **1/12 Oct + Tol** function.

#AutoStart

Enables auto start function. (not mandatory)

True Auto start is active. The run indication displays **A**. The measurement starts automatically after the trigger level is reached. Alternatively the measurement may start manually by pressing start .

False No auto start function. (default setting)

#AutoStartTriggerLevel

Sets the sound level in dBZ for an automated level trigger; the passed/failed measurement starts as soon as the set level e.g. **95** dB is reached or exceeded. The actual input level can be monitored at the input range bar. (mandatory if **#AutoStart** is **True** used otherwise not mandatory)



#AutoStartSettlingTime

Defines the settling time, after the auto start trigger level is exceeded, until the start of the measurement; the time is set in 100 millisecond steps e.g. setting **0.5** equals a settling time of 0.5 seconds. If the input level drops below the auto start trigger level during this period, no measurement is carried out. (not mandatory)

#MeasTime

Defines the measurement time in 100 millisecond steps; e.g. setting **1.5** equals a measurement period of 1.5 seconds. (not mandatory)



10. System Settings

The various system settings of the instrument can be adjusted as follows: Turn the rotary wheel  to navigate to the main menu  and select **System**. Confirm with enter .

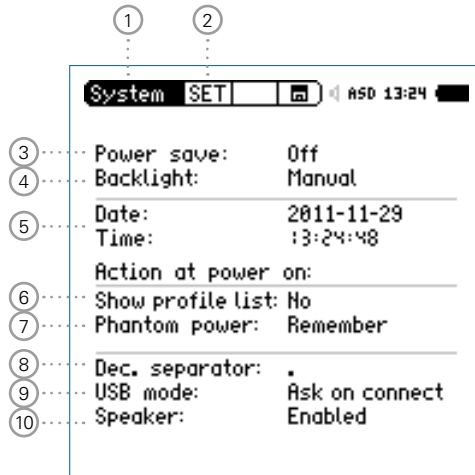
System Settings Page



Display Contrast Setting

- Hold down escape  and turn the rotary wheel  until the desired contrast is reached.

Page Selector

Toggles with the page button  between





SET System setting

INF System information

Sch Scheduler

Power Save

If no button has been pressed for the defined time period, then the power save function switches the instrument off

- Select **Power save** with the rotary wheel .
- Confirm with enter .
- Set the auto power off time with the rotary wheel .
- Confirm with enter .

The power save mode is disabled when a measurement is running or when an external mains power supply is used.

④ Backlight

Auto The backlight switches off if no key is pressed for 2 minutes. Toggle the backlight with the power/backlight button .

Manual The backlight is toggled with the power/backlight button .

- Navigate the cursor to the backlight function.
- Toggle with enter  to set this parameter.







Dimming the backlight reduces the power consumption.

⑤ Date (yyyy:mm:dd) and Time (hh:mm:ss)

The XL2 includes a real-time clock. All measurements are logged with a date and time stamp.

Set the real-time clock as follows:

- Select the **Date** function  with the rotary wheel .
- Confirm with enter .
- Set the date with the rotary wheel .
- Confirm each setting with enter .
- Follow the same procedure for **Time**.

 You have set the real-time clock.

⑥ Show Profile List

You may configure the XL2 to start up with individual preset application profiles. For example, sound level monitoring in accordance with DIN 15905 or SLV 2007.

Yes The instrument starts up with default application profiles. Further details about the application profiles are in the chapter “Profiles”.

No The instrument starts up in the last configuration without any application profiles.

7 Phantom Power



You can select if the phantom power should be activated or disabled when the XL2 is powered up.

Off The phantom power is switched off when the XL2 is powered up. Useful, for example, when it is common to measure lines.

Remember The XL2 remembers the setting prior to the last shutdown. (= default setting)

8 Decimal Separator

Set the decimal separator to match the generated measurement reports to the PC settings. This simplifies data post-processing on the PC.

- Navigate to the **Dec. Separator** function  with the rotary wheel .
- Toggle between “.” and “,” with enter  to set this parameter.

 The decimal separator is set.

9 USB Mode

The following setting defines how the PC recognizes the connected XL2:

Ask on connect Select either the Mass storage or COM port mode after connecting the XL2 to the PC.

Mass storage The PC recognizes the XL2 as a mass storage device automatically, allowing you to download XL2 measurement reports.

COM port The PC recognizes the XL2 as a COM port automatically for application of the XL2 Projector and the Remote Measurement Option.

10 Speaker

Enables/disables the rear speaker. For example, it is recommended that the rear speaker be disabled for all acoustic measurements. This prevents measuring the audio feedback sound loop generated through the rear speaker.

System Information Page

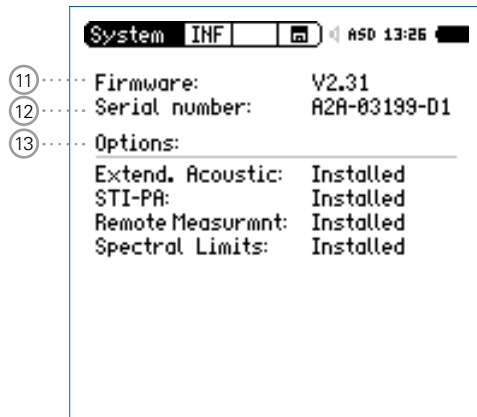

⑪ Firmware

Displays of the firmware version number ⑪ (to update the firmware to the latest version see the chapter “Firmware Update of XL2”).

⑫ Serial Number

Displays the instrument’s serial number ⑫.

⑬ Options

Displays the options installed on the XL2.

Every installed option may be temporarily **Hidden** to generate a profile for other XL2s without this option installed.

- Select the installed option.
- Toggle with enter ↵ to set this parameter.

11. Scheduler

The XL2 Analyzer offers automated scheduled measurements without any human interaction. You may schedule a measurement for one or multiple days.

XL2 Actions after pressing Start Schedule

- Selects the preset measurement function.
- Standby until start time
- Starts measurement at start time
- Stops measurement after the preset measurement duration
- Stores measurement data to SD Card (no reconfirmation required)
- Stops schedule or standby until next start time.

Supported measurement functions:

- SLMeter/RTA
- FFT + Tol
- RT60
- 1/12 Oct + Tol
- STI-PA

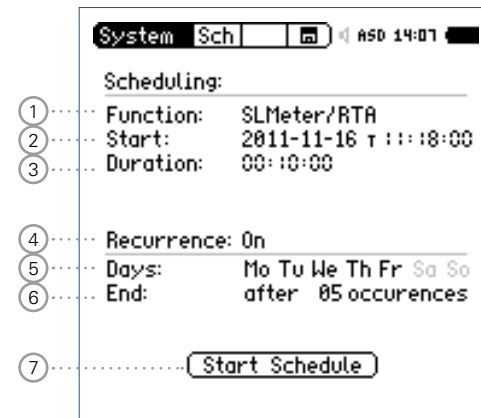





① Function





Select the measurement functions for the scheduled measurements.

② Start Date and Time

Set the date for the scheduled measurement(s):

- Select **Start** with the rotary wheel .
- Confirm with enter .
- Set the date with the rotary wheel .
- Confirm each setting with enter .

Set the time for the scheduled measurement:

- Select the **T** symbol to the right of the date with the rotary wheel .
- Confirm with enter .
- Set the time with the rotary wheel .
- Confirm each setting with enter .

③ Duration

Set the duration of the scheduled measurement(s).

④ Recurrence

Off Schedules a single measurement.

On Schedules a sequence of measurements with the same start and end time times for the selected week days

⑤ Days

Select the week days for the recurrence

⑥ End

Set the number of occurrences of the scheduled measurement. Each single measurement is one occurrence.

⑦ Start Schedule

Starts the scheduled measurement(s).

👉 The **Scheduler active** window is displayed.

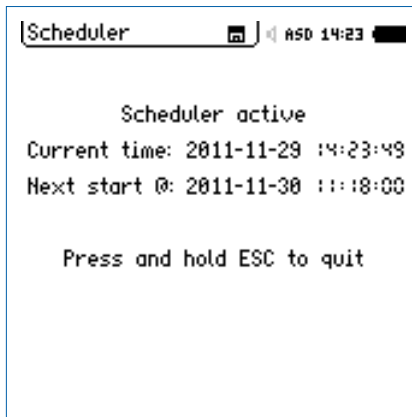

Scheduling - Getting Started

After starting the scheduled measurement, the XL2 waits for the next scheduled start date and time. The instrument buttons are disabled.

Power Supply

It is recommended that the instrument remains powered on until the next start time, using the accessory mains power adapter. If the XL2 is powered off and on again during this time, then the XL2 Analyzer restarts in the **Scheduler** function and continues the countdown. This applies also for any interruption of mains power supply.

Stopping the Schedule



Press and hold the escape button  to stop the schedule.

Operation with PC

Starting the schedule switches the USB interface automatically into the COM port mode for remote measurement applications or using the XL2 Projector software.

12.Data Management

The XL2 stores all acquired measurement data including real-time information onto the removable SD Card. Additionally, wav-files might be recorded and individual voice notes added for a complete documentation of the measurement.

- Carry out a sound level measurement.
- Select the memory menu  in the upper menu bar.
- Press enter . The memory menu opens.

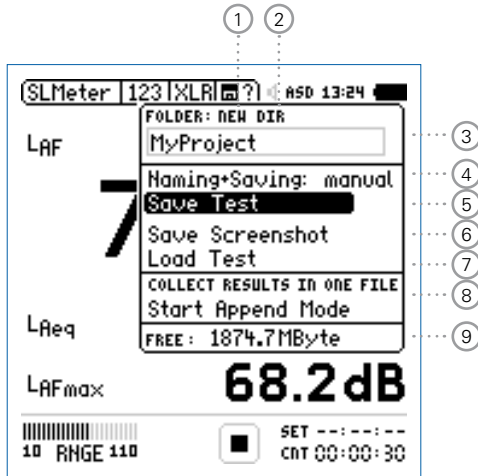

① Create New Project Folder

Add a new folder with an individual project name. The maximum length of the project name is 16 characters. A fast way for creating new folder names is

- Select an existing folder name with **DIR**
- Select **NEW**
- Rename the folder and confirm with start , thereby creating a new folder name.

② Select Project Folder

An overview of all existing project folders is shown. Select a folder to store the results of the measurements.

③ Project Folder Name

All measurements are stored in this project folder.

④ Naming+Saving

Setting of auto or manual data file naming and saving

auto The results are named and stored automatically in the selected project folder.

manual The question mark shows up in the upper menu bar  upon the completed measurement. You can choose to individually name and store each single measurement.

- ⑤ **Save Test**
Stores the measurement in the selected project folder.
- ⑥ **Save Screenshot**
Stores the XL2 screen in the selected project folder.
- ⑦ **Load Test**
Loads back previously stored result data from the SD Card for detailed examination on the instrument screen.
- ⑧ **Append Mode**
The append mode stores one or more results into the same data file, simplifying data analysis and handling on the PC.

Application example:
The speech intelligibility STI-PA shall be measured at various locations in the same venue. The append mode allows you to store all individual measurement results into one single data file.
- ⑨ **Free Memory**
Displays the remaining available memory on the SD Card.



Original SD Cards ensure that all measurement data and audio wav-files are stored in good order on the SD Card. Non-original SD Cards may lead to low performance or error messages.

Order Information:

Spare SD Card, NTi Audio # 600 000 374



In case the SD Card is full, you can insert the original spare SD Card into the XL2 and continue with the measurements. The XL2 generates the projects and system folders automatically.

Memory Structure of SD Card

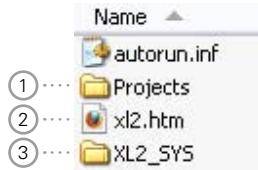

① Projects

The folder **Projects** contains subfolders with the stored measurement results. The default subfolder name is "**MyProject**". You can create further individual subfolders.

② XL2.htm

This file opens the XL2 instrument status page, with

- Serial Number, Firmware
- Installed Options

as well serves for online

- Firmware updates
- Activation of options

③ XL2_SYS

The XL2 system folder contains a file with serial number, firmware version and installed options.

Measurement Data - Getting Started

Enable Data Logging

- Select the **Log** page in the sound level meter function and set the logging parameters; e.g., as follows:

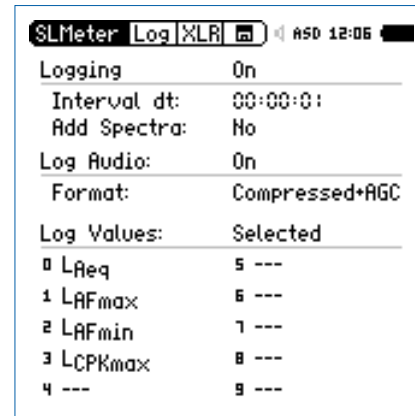



- 👉 The data logging is enabled. The sound pressure level is logged each second.

Select Parameters for Measurement Report

- Select the **Rep** page in the sound level meter function and set the parameters as follows:



Complete the Measurement

- Press page  to return to the numeric result page.
- Press start . The sound level measurement is now running.
- Press stop  to complete the sound level measurement.

 The memory question mark  shows up in the upper menu bar after the completed measurement.

Open the Memory Menu

- Select the memory menu with the rotary wheel and confirm with enter .

The memory menu opens with “**Save Test**” pre-selected.



- Press enter to confirm **Save Test**.

The pop-up window **Save Test** shows up.

Select File Name



- Select the user part of the file name. The maximum length of the user part is 12 characters. The right part “**_SLM_001**” is defined by the XL2 to avoid overwriting of existing measurements, whereby “**SLM**” is the appendix for the measurement function and “**001**” is an automatically-incrementing number.

Record Voice Notes

Voice notes are recorded speech annotations for each stored measurement. The XL2 utilizes the internal voice note microphone for the recording.

- Select **Record Voicenote** and press enter ↵.



- Select **REC** and press enter ↵.
- Record the voice note and press enter ↵ to finish.

👉 The voice note has been recorded.

Save Measurement Data Manually



- Select **SAVE** and confirm with enter ↵.

👉 The measurement data including test configurations and all log files are stored on the SD Card.



Overwrite File

Tick off **Automatic Numbering** to store actual measurement results for later overwriting with new results.

Save Screenshot

- Select the memory menu with the rotary wheel and confirm with enter .

The memory menu opens.

- Select **Save Screenshot** and press enter .
- Select the file name and confirm **SAVE** with enter .

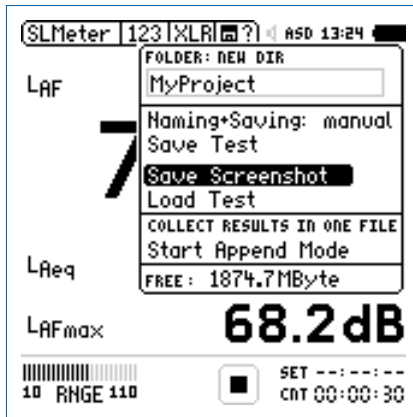

The screenshot is saved to the SD Card.

Name + Save Measurement Data Automatically

You may configure the XL2 to store results automatically to the SD Card upon completion of the measurement, by applying the **Naming+Saving: auto** function. This is particularly useful for longer measurements, such as sound level monitoring spanning several hours. The default file name is the actual date.

- Select **Naming+Saving** in the memory menu and press enter to confirm **Naming+Saving: auto**.

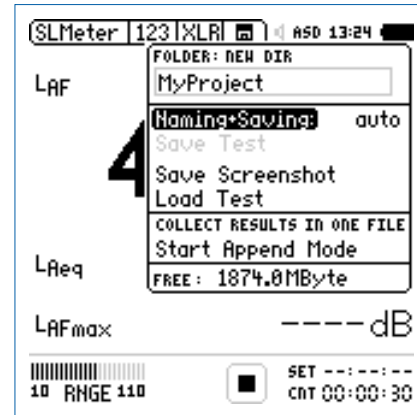

Measurement Data Logging:

If the battery runs empty while you are measuring with logging and/or repeated-reporting enabled, the XL2 creates the folder RESTORE_AFTER_POWERFAIL and stores the measurement data up until the switch-off time. The next time you switch on the XL2, the following window informs you that this data exists. Click OK:



The files may contain invalid data at the end of the file, which you may delete to create a valid report.

View Project Folder on the PC

- Connect the XL2 with the USB cable to the PC.

👉 The pop-up window **USB Mode** shows up.

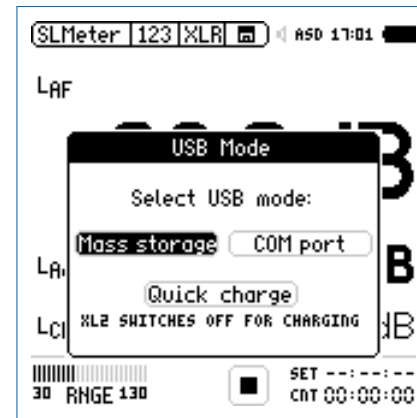

- Select **Mass Storage** and confirm with enter ↵.

- 👉 The PC recognizes the XL2 as a mass storage device. The following SD Card content is shown:



- Open the folder “Projects” and the subfolder “MyProject”

- 👉 All stored measurement data files are shown.



If the XL2 is started with USB connection to PC, then the COM port mode is automatically activated for remote measurement or the XL2 Projector software. Therefore, if you want to access the data in the SD Card, then start the XL2 first and connect the USB cable to the PC afterwards.

Overview of Measurement Data Files

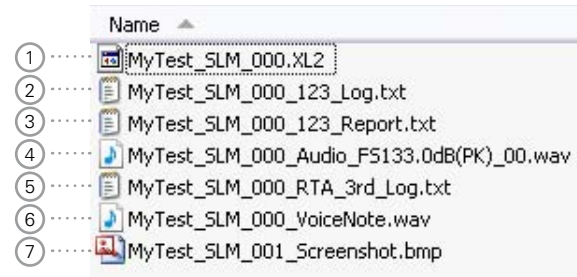

① Test System File

System file for use by XL2 only. It contains the measurement data and test configuration of the last measurement cycle for later reload and view of measurement results in the XL2.

② Sound Level Log File

The XL2 logs sound levels in pre-defined log time intervals. For more details please see the chapter “Sound Level Meter” -> “Logging”.

③ Measurement Report File

Final report after the completed measurement. For more details please see the chapter "Sound Level Meter" -> "Reporting".

④ Wav-File

The wav-file is the recorded audio file. The index "FS133.0dB(PK)" in file name represents the full scale peak level of the recorded wav-file. For more details please see the chapter "Sound Level Meter" -> "Wav-File Recording".

⑤ RTA Log File

The XL2 logs the detailed real-time analyzer spectra in pre-defined time intervals. For more details please see the chapter "Sound Level Meter" -> "Logging".

⑥ Voice Note

A voice annotation can be recorded for each stored measurement or screenshot. For more details please see the chapter "Data Management" -> "Voice Notes".

⑦ Screenshot

Picture of the actual XL2 display.

Transfer Measurement Data to PC

- Drag and drop the required data files to the PC.



Card Reader

Alternatively the SD Card can be inserted into a card reader. This offers a faster data transfer from the SD Card to the PC.



Additional Data Files using Repeat Mode

For sound level measurements with timer mode Repeat or Repeat Synchronized the following additional data files are generated:

- MyTest_SLM_000_123_Report_Rep.txt
- MyTest_SLM_000_RTA_Report_Rep.txt

Common xxx_Report.txt files contain the measurement data of the last measurement cycle. The xxx_Report_Rep.txt file contains the results of all measurement cycles in the Repeat or Repeat Synchronized mode.

Log File Format

File name: e.g. MyTest_SLM_000_123_Log.txt

Date	Time	Timer	LAeq dt	LAeq	LAFmax dt	LCPKmax dt
[YYYY-MM-DD]	[hh:mm:ss]	[hh:mm:ss]	[dB]	[dB]	[dB]	[dB]
15.11.2010	17:44:07	00:00:01	97.0	97.0	102.4	119.0
15.11.2010	17:44:08	00:00:02	85.8	94.3	91.9	105.7
15.11.2010	17:44:09	00:00:03	73.8	92.5	85.2	102.4
15.11.2010	17:44:10	00:00:04	79.0	91.4	85.3	103.9
15.11.2010	17:44:11	00:00:05	72.6	90.4	75.9	94.8
15.11.2010	17:44:12	00:00:06	67.3	89.6	71.4	87.3
15.11.2010	17:44:13	00:00:07	91.2	89.9	95.3	112.3
15.11.2010	17:44:14	00:00:08	92.7	90.4	97.1	113.2
15.11.2010	17:44:15	00:00:09	79.3	89.9	81.6	97.9



Microsoft Excel

The generated .txt files are best viewed on the PC using "Open with" -> Microsoft Excel.

Report File Format

File name: e.g. MyTest_SLM_000_123_Report.txt

Date	Time	Date	Time	LAeq	LCPKmax
[YYYY-MM-DD]	[hh:mm:ss]	[YYYY-MM-DD]	[hh:mm:ss]	[dB]	[dB]
15.11.2010	17:44:06	15.11.2010	17:44:16	89.3	119.0

Data Post-Processing

A Microsoft Excel form generating an automated sound level measurement report and chart is available as a free download for all registered XL2 customers on the support website at <http://my.nti-audio.com>. (Enable all macros when opening the document.)

Recall Measurements

The straight-forward but powerful **Load Test** and **Save Test** functions serve the dual purpose of conveniently retrieving standard test setups for repeat testing and also of saving stored result data for later recall and examination on screen.

The following measurement functions support the recall function:

- SLMeter, sound level meter
- FFT Analysis
- RT60, reverberation time
- STI-PA, speech intelligibility measurement

Load Test

- Select the memory menu  with the rotary wheel  and confirm with enter .

 The memory menu opens.

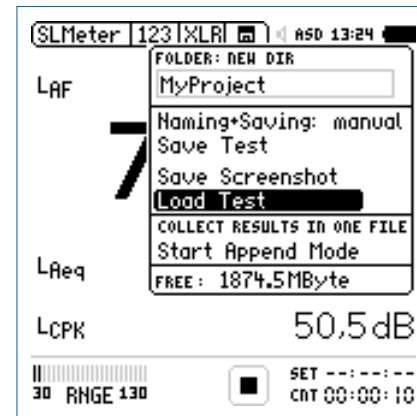

Select File Name

- Select **Load Test** and confirm with enter ↵.

👉 The pop-up window **Load Test** shows up.



- Select the project folder and stored data file name with **DIR**.
- Select **LOAD**, confirm with enter ↵.

View Measurement Data

👉 The previously stored measurement data is displayed.

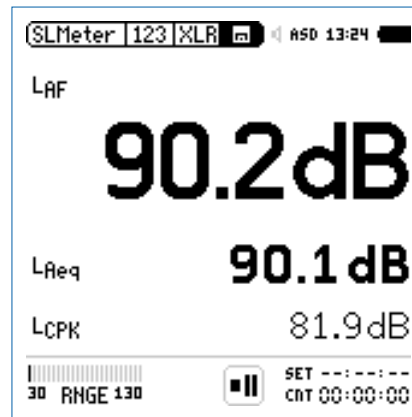

⋮
①

The run indication ① shows the pause symbol. You may continue with the measurements directly, e.g., choose the measurement function, setup parameters and press start

Append Measurements

The append mode stores the results of several individual measurements into the same data file, thus simplifying measurement result analysis and data handling on the PC.

The following measurement functions support the append mode:

- SLMeter, sound level meter
- STI-PA, speech intelligibility measurement



Application example:

The sound level L_{Aeq} shall be measured at various locations in the same venue hall using a pink noise test signal. The append mode allows to store all individual measurement results into one single data file.



Backup the stored measurement data from the XL2 to the PC daily. This prevents any data loss if data has been deleted from the SD Card by mistake.

Start the Append Mode

- Select **SLMeter** and preselect the sound level L_{Aeq} .
- Select the memory menu  with the rotary wheel  and confirm with enter .

 The memory menu opens.

- Select **Start Append Mode** and confirm with enter .

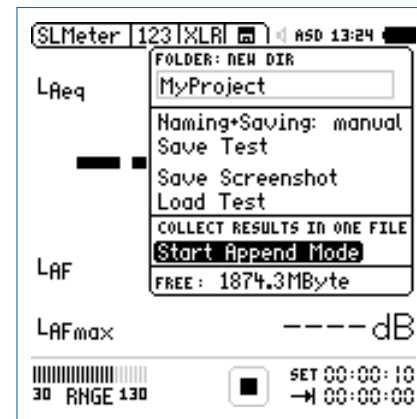

 The **Start Append Mode** window opens.

Select Filename



- Select the user part of the file name. The maximum length of the user part is 12 characters. The right part “**SLM_001**” is defined by the XL2 to avoid overwriting of existing measurements, whereby “**SLM**” is the appendix for the measurement function and “**001**” is an automatically-incrementing number.
- Select **START** and confirm with enter ↵.

👍 The append mode is available.

Take Measurement Results

- Measure the sound level L_{Aeq} on the first position.
- Select the memory menu and **Append Data**.





In append mode, the XL2 does not store:

- Log files
- Wav-files
- Repeated report files generated in timer mode **repeat** and **repeat synchronized**.

Store Measurement Results

👉 The pop-up window **Append Data** shows up.

- Select the location ID and measurement ID, thus each measurement result is stored with an individual description for later documentation.
- Select **Append** with the rotary wheel  and confirm with enter .



👉 The measurement data is stored on the SD Card.

Append Further Measurement Results

- Move to the next location in the room, carry out the measurement and follow the described append data procedure.

Exit Append Mode

- Open the memory menu .
- Select **Exit Append** after adding the last measurement.



Auto Append

Alternatively the XL2 can append measurement data to the same report file automatically.

- Start the Append mode and set **Auto Append is ON** in the memory menu or in the pop-up window **Start Append Mode**.

Skip Append Data

If you select **SKIP** in the **Append Data** window, then no measurement data is appended to the report file.

Append After Power Up

You can continue to add measurement results into the same data file at any time later.

- Store the measurements in the append mode and switch the XL2 off and on again

The pop-up window **Continue append** shows up.

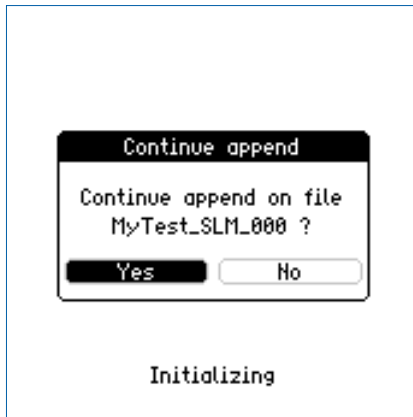

- Select **Yes** and continue adding measurement results to the same report file in the append mode.

Recall Previous Measurements for Append

Any previously stored measurement with the remark **for append** can be recalled and further test records appended.

- Select **Load Test** and press enter
- Select the project folder and stored data file name.
- Select **LOAD** confirm with enter

The pop-up window **Load for Append** shows up.

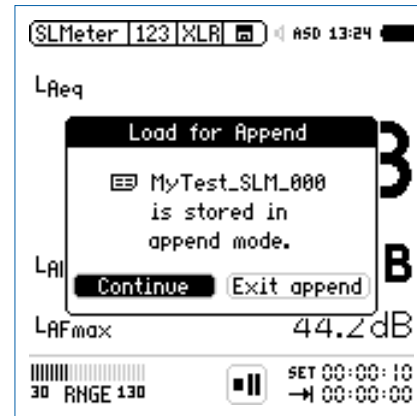

- Select **Continue** and add further measurements to the same report file in the append mode.

13. XL2 Projector

The XL2 Projector displays the XL2 screen in real-time on your PC when connected by USB. The software toolbar enables control of the XL2 Audio and Acoustic Analyzer with the mouse and keyboard. XL2 Projector software is a free download for all registered XL2 customers on the support website at <http://my.nti-audio.com>.

The XL2 Projector background color synchronizes with the XL2 limit button color .



USB Communication

The XL2 Projector uses the USB connection in COM port mode.

Installation instruction:

- Register your XL2 and download the XL2 Projector software from the XL2 Support Page on <http://my.nti-audio.com>.
- Unzip the file “XL2 Projector Setup Vxx.zip” on your PC.
- Start the software installation and follow the instructions including driver installation.
- Start the XL2 Projector software.
- Start the XL2.
- Connect the XL2 Analyzer to the PC.

 The pop-up window **USB Mode** shows up.

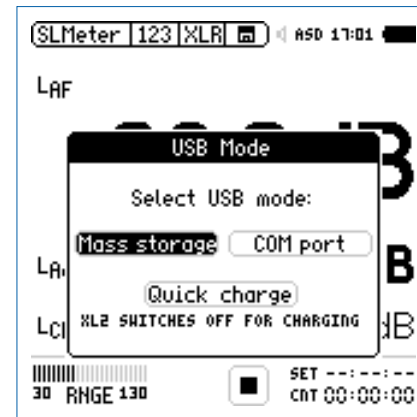

- Select **COM port** on the XL2. Microsoft Windows may recognize the new hardware automatically and start the hardware installation assistant.
- If prompted, select “No connection to Windows Update” and continue with the installation.
- Complete the installation.

👉 XL2 Projector displays the instrument screen in real-time.

Features

- The upper window bar displays the XL2 serial number.
- The menu bar supports remote instrument operation of the XL2 Analyzer from your PC.
- All data stored on the SD Card can be accessed directly from the XL2 Projector software. Complete your measurements and click on the SD Card symbol.

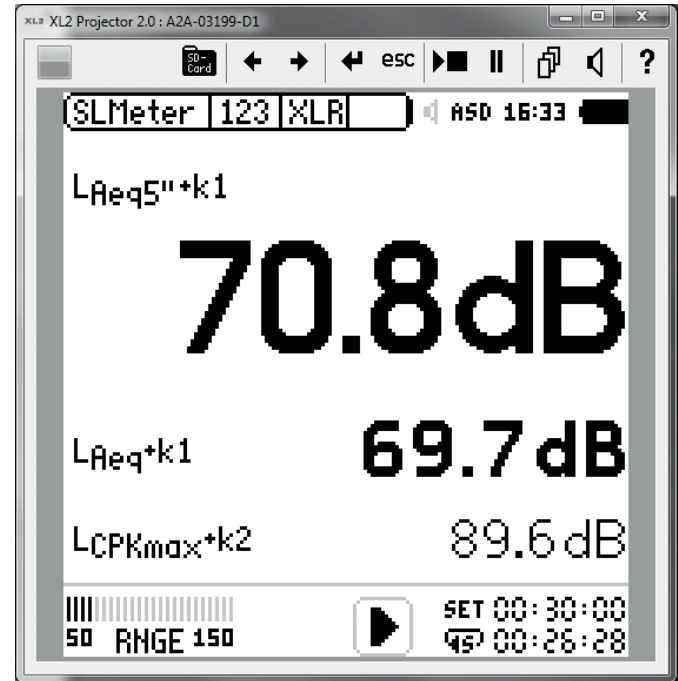

For more details and features click the ? symbol on the XL2 Projector Software.

14. Noise Monitoring Network

Multiple XL2 Analyzers connect with USB Device Servers to a network for online noise monitoring. An instance of the Projector Software may be started for each XL2 Analyzer, with all XL2 screens being simultaneously displayed on the PC monitor. The Projector Software offers the control of each XL2 Analyzer from your PC.

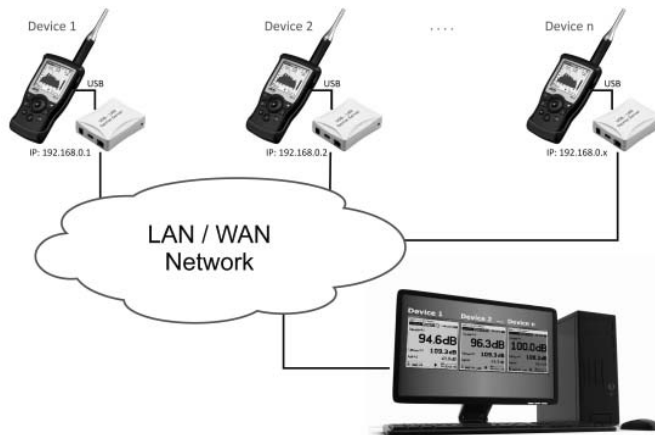

Please contact NTi Audio for application details.

15. Remote Measurement

The XL2 Analyzer offers an optional remote measurement function. This allows querying the XL2 measurement data online via the USB interface. Thus customers may program their own measurement application on the computer, e.g. for sound level monitoring or automated measurement tasks. The supported XL2 measurement functions are

- Sound level meter and spectrum analyzer SLMeter/RTA
- Audio analyzer RMS/THD+N

The commands are sent in ASCII format through the virtual COM port to the XL2 Audio and Acoustic Analyzer.

Example:

- Command set send to XL2 Analyzer:
INIT START
MEAS:INIT
MEAS:SLM:123? LAF
- Result returned to PC:
53.8 dB,OK

For more details you may download the individual Remote Measurement Reference Manual at www.nti-audio.com/XL2.

Order information NTi Audio #: 600 000 339

16. Microphones

NTi Audio Microphone Overview



M2210 Measurement Microphone

- 1/2" Omni-directional free-field microphone
- Class 1 frequency response according IEC 61672-1 (individual frequency response available as Excel-data)
- Phantom power 48 VDC
- Electronic data sheet installed
- Frequency range 5 Hz - 20 kHz
- Dynamic range 19 - 144 dB
- Build-in pre-amplifier

NTi Audio #: 600 040 020



M2215 Measurement Microphone

Same specifications as M2210 except:

- Dynamic range 30 - 155 dB

NTi Audio #: 600 040 045



M4260 Measurement Microphone

- 1/4" Omni-directional free-field microphone
- Class 2 according IEC 61672-1 (individual frequency response available as Excel-data)
- Phantom power 48 VDC
- Electronic data sheet installed
- Frequency range 5 Hz - 20 kHz
- Dynamic range: 29 - 144 dB
- Build-in pre-amplifier

NTi Audio #: 600 040 025



MA220 Microphone PreAmplifier

- 1/2" low noise microphone preamplifier
- Electronic data sheet installed
- Compatible with standardized 1/2" microphone capsules, such as B&K, Gras, MTG, ...

NTi Audio #: 600 040 040

The plug-on measurement microphones combined with the XL2 form a comprehensive sound level meter and acoustic analyzer. The microphones are 48 VDC phantom-powered and include an electronic data sheet.

Integrated Preamplifier

The microphone bodies contain a pre-amplifier and require 48 VDC phantom power supply for operation. They combine high dynamic range and wide frequency range with low noise. The measurement microphones can also be connected with an ASD Cable to the XL2 Audio and Acoustic Analyzer for measurements at remote locations or for reduction of acoustic reflections.

Electronic Data Sheet

The NTi Audio's ASD measurement microphones and the microphone preamplifier MA220 include an electronic data sheet. The automated sensor detection (ASD) of the XL2 Analyzer reads this data sheet, enabling the XL2 to automatically recognize the microphone model, sensitivity and calibration data. This ensures correct measurement results.

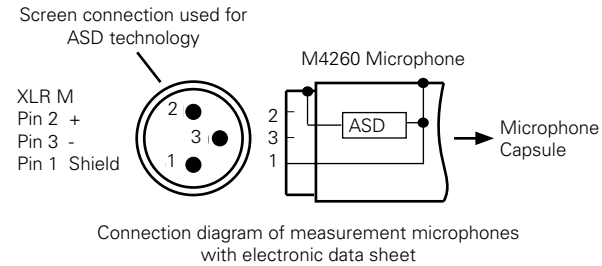

Microphone plugs directly in to the XL2

The XL2 automatically reads the ASD electronic data sheet of the connected microphone as follows:

- Connect the measurement microphone to the XL2.
- Switch on the XL2 🔄.

👉 The XL2 reads the electronic data sheet of the connected microphone during a brief initialization process prior to the first measurement.

Microphone Connection via the ASD Cable

The NTi Audio measurement microphones and the microphone preamplifier MA220 can be connected with an ASD Cable to the XL2 Audio and Acoustic Analyzer for measurements at remote locations or for reducing acoustic reflections. The ASD Cable includes a separate line for transmitting the electronic data sheet to the XL2, thereby not affecting the measurement data.

The electronic data sheet is transmitted via the XLR connector's housing and the shield lead of the ASD Cable. Do not touch these parts during the brief initialization period to ensure the complete data sheet is recognized by the XL2. The automated sensor detection does not disturb any measurements. You may join up to 4x ASD Cables together in series. The ASD technology supports accurate data communication up to a combined cable length of 20 meters (= 65 feet).

Microphone Connection via a professional Audio Cable

For distances longer than 20 meter (= 65 feet) use a high quality, low capacitance standard professional audio cable. In this scenario, no separate data line for the transmission of the electronic data sheet is available, thus the microphone sensitivity has to be entered manually into the XL2 Analyzer.



- Use the microphone for the intended purpose only.
- Protect the microphone from contamination by always using the supplied windscreen.
- Never use the microphone in a damp or wet environment.
- Do not jar or drop the microphone.
- Do not remove the microphone protective grid.
- Do not touch the microphone membrane.
- Remove the black dust cap of the 1/2" measurement microphones prior to use.

17. Further Information

Registration

Register as a customer with NTi Audio and benefit from the following possibilities:

- Keep your product up-to-date
Access free firmware and software updates.
- Activate options
Enable additional functions for your product.
- Access premium content
Access downloads, information and specific support for your product.
- Receive application and product news
Sign in for the NTi Audio Newsletter.
- Get fast worldwide support
Register your product for fast support.
- Confirm your ownership
Allows us to contact you with important product notifications and monitor your product in case of loss or theft.

How to Register

- Open the web page “<http://my.nti-audio.com>”
- You are prompted to login or create your My NTi Audio Account.
- The web page “My NTi Audio Products” opens.
- Select the product type and enter the serial number of your product.
- Confirm with “Register”.
- Now your product is listed in the table “My Products”.





Congratulations, your NTi Audio product is registered.

Tips and Troubleshooting

Resetting to Factory Default

If the XL2 Audio and Acoustic Analyzer reacts unexpectedly, a reset to the factory settings might solve the problem.

- Switch off the XL2 .
- Hold down escape  and simultaneously operate On/Off .

 The reset confirmation is displayed.

XL2 Starts Up with Limited Functions

The XL2 has been operated the last time in one of the simplified application profiles and the system settings have been changed as follows: **Select Profile** from **Yes** to **No**.

- Follow the above resetting to factory default.

 The XL2 will start up with full functionality.

SD Card Errors

The XL2 Audio and Acoustic Analyzer writes measurement data automatically onto the SD Card during ongoing measurements, thus a functioning SD Card has to be inserted at all times.

Error Messages

Actions to do

Missing SD-Card

Insert the SD Card.

SD-Card is not FAT formatted



Format the SD Card on the PC.

SD-Card is full

The memory of the SD Card is full. Download all data to the PC and empty the SD Card.

Can I use another SD Card ?

Yes, you can use any alternative SD Card.

- Switch off the XL2 .
- Insert the SD Card into the XL2 Analyzer.
- Switch on the XL2 .

 The XL2 writes the data structure automatically to the inserted SD Card.

Stored Data or Wav-files not available on SD Card

The file system might be corrupted.

- On the PC, right-click on the "NTi Audio XL2" drive, select "Properties" and click "Check Now" as shown below.
- Thereafter all stored data should be available again.

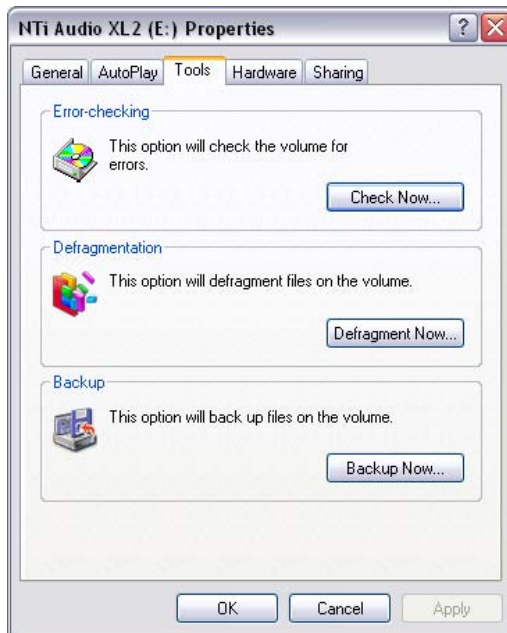

Firmware Update

You will find information about the installed firmware version in the systems settings of the instrument. The firmware revision history is listed on the XL2 support page <http://my.nti-audio.com>.

Updating the firmware on the XL2 is executed by placing the XL2Vxxx.xx file in the root directory of the XL2. When started, the XL2 automatically completes the firmware update.



① XL2.htm

This file opens the XL2 instrument status page, for online

- Firmware updates
- Activation of options

Firmware update with XL2 in hand, PC online:

- Start the XL2 and connect it to the PC.
- The XL2 displays the pop-up window USB Mode.
- Select Mass storage. The PC thus recognizes the XL2 as a mass storage device.
- Double-click the file xl2.htm ①. The web screen “XL2 Instrument Status” opens.
- Select “Look for FW Updates”: The web screen “XL2 Support Page” opens.
- Compare the firmware version to the latest version available.
- If an update is required, download and save the firmware file XL2Vxxx.xx into the XL2 root directory.
- Remove the USB cable and power up the XL2 ②.
- Watch the display and wait until the update is finished.

No PC available

If you have no web access at all, please contact the local NTi Audio partner. You will receive the new firmware file.

Options and Accessories

The **System** menu shows the installed options on the XL2. The following options extend the measurement functions of the XL2:

Speech Intelligibility STI-PA

NTi Audio #: 600 000 338

The STI-PA function measures the speech intelligibility of public announcement systems in accordance with the latest revision of the IEC 60268-16:2003 standard. The XL2 displays the measurement results as STI or CIS, accompanied by the individual levels and modulation indices of the seven octave bands. The measurement results are acquired from the dedicated STI-PA test signal, generated by the

- Test Signal CD included with the XL2
- Minirator MR-PRO test signal generator; required for audio systems with line inputs
- NTi Audio TalkBox acoustic signal generator; required for audio systems with voice microphones, in order to measure the complete signal chain

Extended Acoustic Pack

NTi Audio #: 600 000 339

The Extended Acoustic Pack offers the following additional features for sound level- and acoustic measurements.

- SLMeter/RTA function
 - Percentiles for wide band and spectrum: 1%, 5%, 10%, 50%, 90%, 95%, 99%
 - Time weighting: Impulse
 - Sound Pressure Levels L_{Leq}
 - Sound Exposure Level L_{AE}
 - Event-triggered audio and data recording
 - Recording of linear wav-files (24 bit, 48 kHz)
 - True peak level in 1/1 and 1/3 octave resolution
 - Clock-Impulse Maximum Level (TaktMax) and values as specified in DIN 45645-1
- FFT function
 - High-resolution Zoom-FFT with selectable frequency ranges and resolution up to 0.4 Hz in the range of 5 Hz to 20 kHz
- RT60 function
 - Reverberation time RT60 in 1/3 octave resolution

Remote Measurement Option

NTi Audio #: 600 000 375

The Remote Measurement Option allows querying of the XL2 measurement data online via the USB interface. Thus customers may program their own measurement application on the computer, e.g. for sound level monitoring or automated measurement tasks.

The supported XL2 measurement functions are

- Sound level meter and spectrum analyzer SLMeter/RTA
- Audio analyzer RMS/THD+N

Spectral Limits Option



NTi Audio #: 600 000 376

The Spectral Limits Option extends the XL2 function range with trace capturing, relative curve display and comprehensive tolerance handling for the FFT Analysis and the new high resolution RTA with spectral resolutions up to 1/12th octave.

- SLMeter/RTA function
 - True peak level in 1/1 and 1/3 octave resolution
- FFT function
 - High-resolution Zoom-FFT with selectable frequency ranges and resolution up to 0.4 Hz in the range of 5 Hz to 20 kHz
- 1/12 octave function
 - High resolution RTA function **1/12 Oct + Tol**
 - Selectable 1/1, 1/3, 1/6 and 1/12 octave spectral resolution
- FFT and 1/12 octave function
 - Capturing of multiple readings into the internal memory
 - Comparing measurement results against captures with relative or absolute curve display
 - Comprehensive tolerance handling
 - Creating tolerance masks based on captures for passed/failed measurements
 - Export and import of tolerance and capture files

Installation of Options

Activation with PC online (recommended):

- Start the XL2 and connect it to the PC.
- The XL2 displays the pop-up window USB Mode.
- Select **Mass storage**. The PC thus recognizes the XL2 as a mass storage device.
- Double-click the file xl2.htm . The web screen “XL2 Instrument Status” opens.
- Select “Activate Option”. The web page “http://my.nti-audio.com” opens.
- You may login or create your My NTi Audio Account.
- The web page “My Products” opens. The XL2 Analyzer is listed with its Serial Number on this page.
- Enter the license number printed on the rear side of the CD cover and click “Get Activation Key”.
- The activation key file is then available for download.
- Copy this activation key file into the root directory of the XL2 memory (=SD Card).
- Remove the USB cable and power up the XL2 .
- Congratulations, the purchased option is now permanently enabled on the instrument.

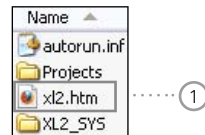

Manual Activation:

(applicable if the XL2 can not be connected to an online PC)

- Open the web site “http://my.nti-audio.com”.
- You may login or create the My NTi Audio Account.
- The web page “My Products” opens. Register the XL2 by choosing Product Name “XL2 Analyzer” and entering the unique Serial Number (e.g., A2A-xxxxx-xx), listed in the XL2 battery compartment or shown in the XL2 system settings.
- Click “Register”. The XL2 Analyzer is now listed with its Serial Number on this page.
- Enter the license number printed on the rear side of the CD cover and click “Get Activation Key”.
- The activation key file is then available for download.
- Copy this activation key file into the root directory of the XL2 memory (=SD Card).
- Remove the USB cable and power up the XL2 .
- Congratulations, the option is now enabled on the XL2.



Kindly use the license number on the back of the CD cover. This license number is valid for one XL2 Analyzer.

Accessories



Ever-ready Pouch

The Ever-ready Pouch protects the XL2 during transport and operation. With its convenient belt-clip, the XL2 can be kept close-by for those tasks requiring both hands. The Ever-ready Pouch allows operation of the XL2 while fitted in the pouch.
NTi Audio #: 600 000 335



Mains Power Adapter

Mains Power Adapter the XL2 Audio and Acoustic Analyzer with removable plug types. The Mains Power Adapter suits the typical power sockets in Australia, China, Europe, Japan, US and UK.
NTi Audio #: 600 000 333



Spare Li-Po Battery

Rechargeable spare battery for portable measurements at any time.
NTi Audio #: 600 000 337

Spare SD Card 2 GByte

NTi Audio #: 600 000 374



48V -> ICP® Adapter

Connects to the XL2 and generates ICP power supply for alternative microphones or sensors.

Specifications:

(@ sensor sensitivity = 50 mV/Pa and output impedance < 100 Ohm)

- Residual Noise Floor typical: 17 dB(A)
- Maximum SPL: 140 dB

NTi Audio #: 600 010 223

ICP® is a registered trademark of PCB Piezotronics.



ASD Cable

The ASD Cable allows for extended connections of the NTi Audio measurement microphones or microphone pre-amplifier MA220, while maintaining the automated sensor detection functionality (ASD). You may chain up to 4x ASD Cables together in tandem.

Length = 5 meter (16 feet)

NTi Audio #: 600 000 336



Exel System Case

This compact system case provides the professional transport protection for work in the field. It offers space for the hand-held instruments, cables and connectors.
NTi Audio #: 600 000 334



Calibration Certificate

Individual calibration certificate with serial number in accordance with the standards EN ISO / IEC 17025.
NTi Audio #: 600 000 018



XL2 Mounting Adapter

Mechanical adapter piece to mount the XL2 on a microphone stand.
NTi Audio #: 600 000 372



Battery Charger

The Battery Charger contains a sophisticated charge controller for efficient charging of the spare Li-Po battery. The battery charger includes 1x spare Li-Po battery.
NTi Audio #: 600 000 332



Digital I/O Adapter PCB

The Digital I/O Adapter serves to control external peripheral devices, such as indicating sound levels that exceed limits on a big external red-orange-green lamp. It connects to the digital I/O interface.
NTi Audio #: 600 000 380



SPL Stack Light with I/O Adapter Box

The XL2 Audio and Acoustic Analyzer together with the Digital I/O Adapter Box control the external SPL Stack Light. It indicates sound levels that exceed limits in orange or red color. The Digital I/O Adapter connects to the digital I/O interface of the XL2 Analyzer.

Applications:

- Sound level monitoring at live events or clubs
- Industrial noise pollution monitoring

NTi Audio #

Digital I/O Adapter Box: 600 000 381

SPL Stack Light: 600 000 382



Precision Calibrator 94/114 dB, Class 1

The precision calibrator ensures accurate sound level measurements. It generates 94 or 114 dB SPL reference tones @ 1kHz for calibration of 1/2" and 1/4" measurement microphones (compatible with all NTi Audio microphones).

NTi Audio #: 600 000 390



Minirator MR-PRO

The MR-PRO is an extremely powerful analog audio generator designed for the professional engineer. It generates the following analog audio signals:

- Sine Waveforms, freely selectable frequencies and levels up to +18 dBu
- Sweep Signals, any frequency interval up to 1/12 octave
- White Noise, Pink Noise
- Polarity Test Signal
- Delay Test Signal
- Uploaded wav-files (*.wav)

NTi Audio #: 600 000 310



XL2 Input Keypad

The XL2 Input Keypad offers four marker keys to trigger an event recording or categorize any noise during measurements. Requires the optional Extended Acoustic Pack.

NTi Audio #: 600 000 384



NTi Audio TalkBox

The NTi Audio TalkBox greatly simplifies the acoustic feed of the STI-PA intelligibility test source signal into closed sound reinforcement systems. It presents the standardized voice-like acoustic signal emission simulating a human talker in accordance with IEC 60268-16, combined with a TNO-certified speech intelligibility signal at standardized levels.

NTi Audio #: 600 000 085

Warranty Conditions

International warranty

NTi Audio guarantees the function of the XL2 Audio and Acoustic Analyzer and the individual components for a period of one year from the date of sale. During this period, defective instruments will either be repaired free of charge or replaced.

Limitations

These guarantee provisions do not cover damage caused by accidents, transportation, incorrect use, carelessness, accessories or the installation of any parts that were not delivered with the instrument, the loss of parts, connection to the mains voltage, operation with non-specified input voltages, adapter types or incorrectly inserted batteries. In particular, NTi Audio accepts no responsibility for subsequent damage of any kind. The warranty will be voided by the carrying out of repairs or service work by third parties who are not part of an approved NTi Audio Service Centre.

Repairs

If the XL2 is not functioning correctly or is damaged, please contact the local NTi Audio partner for assistance. If the instrument needs to be returned for service, kindly follow the service guidelines at www.nti-audio.com/service.

Calibration Certificate

The XL2 Audio and Acoustic Analyzer has been carefully tested during production and corresponds to the specifications listed in "Technical Data".

NTi Audio recommends annual calibration of the instrument. Kindly follow the service guidelines at www.nti-audio.com/service.



Damage through shocks and moisture

- The protective shock jacket shields the instrument against reasonable impacts that could occur in normal use.
- Do not intentionally subject the instrument to extreme stress!
- Please do not drop the instrument!
- Damage caused by dropping or impact is not covered by warranty.
- Do not use the instrument in damp environments! The instrument can be permanently damaged if exposed to moisture.

Declaration of Conformity

CE / FCC Compliance Statement

We, the manufacturer

NTi Audio AG
Im alten Riet 102
9494 Schaan
Liechtenstein, Europe



do hereby declare that the XL2, M4260, M2210, MA220 and accessories, comply with the following standards or other standard documents:

EMC: 89/336, 92/31, 93/68

Harmonized standards: EN 61326-1

This declaration will become invalid if modifications to the instrument are carried out without the written approval of NTi Audio.

Date: 1. December 2011

Signature:



Position: Technical Director

Information for Disposal and Recycling

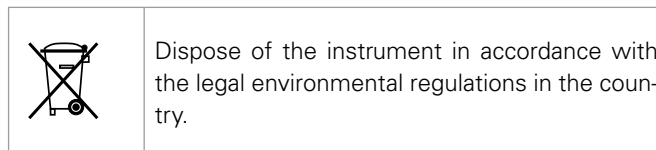

Regulations for the European Union and other European countries with corresponding laws:

The instrument must not be disposed of in the household garbage. At the end of its service life, bring the instrument to a collecting point for electrical recycling in accordance with the local legal regulations.

Other countries outside the European Union:

Contact the respective authorities for the valid environmental regulations in the country.

18. Technical Data XL2

Sound Level Meter	
Product Configurations	<ul style="list-style-type: none"> • XL2 with M2210 microphone <ul style="list-style-type: none"> » Class 1 frequency response in accordance with IEC 61672 » Type 1 frequency response in accordance with ANSI S1.4 • XL2 with M4260 microphone <ul style="list-style-type: none"> » Class 2 in accordance with IEC 61672 » Type 2 in accordance with ANSI S1.4
Conforms with Standards	<ul style="list-style-type: none"> • IEC 61672, IEC 60651, IEC 60804, IEC 61260 class 0, ISO 2969 • China: GB/T 3785:2010, GB/T 3241, GB 3096-2008, GB 50526, GB-T_4959-1995 • Germany: DIN 15905-5, DIN 45645-2, optional: DIN 45645-1 • Japan: JIS C1509-1:2005, JIS C 1513 class 1, JIS C 1514 class 0 • Switzerland: SLV 2007 • US: ANSI S1.4, ANSI S1.43, ANSI S1.11-2004 class 1 • International IEC standards are adopted as European standards and the letters IEC are replaced by EN. XL2 conforms to these EN standards.

Measurements	<ul style="list-style-type: none"> • SPL actual, Leq, Lmin, Lmax, LCpeak • Gliding LAeq with t = 5', 10', 15' and 60' • All measurement results simultaneously available • Correction value measurement wizard • Noise curves NC, NR, PNC, RC with post-processing • Noise exposure level LEX with post-processing • Logging all data or subsets in selectable intervals • Recording of wav-files (ADPCM), a new wav-file starts every 12 hours (max. wav-file size 512 MB) • Recording of voice notes • Monitoring of sound levels that exceed limits • Digital I/O interface for external peripherals control • Level resolution: 0.1 dB • Internal noise: 1.3 µV A-Weighted
Weighting	<ul style="list-style-type: none"> • Frequency weighting: A, C, Z • Time weighting: Fast, Slow, optional: Impulse • Measurement bandwidth (-3dB): 2 Hz to 23.6 kHz
Linear Measurement Range	<ul style="list-style-type: none"> • XL2 + M2210: 28 dB(A) - 144 dB in accordance with IEC 60804 • XL2 + M4260: 35 dB(A) - 144 dB in accordance with IEC 60804
Real-Time Analyzer RTA	<ul style="list-style-type: none"> • Frequency resolution: 1/3 octave, 1/1 octave, wide band • Frequency range: 6.3 Hz to 20 kHz, level resolution: 0.1 dB • Band pass filters conform with IEC 61260 class 0, ANSI S1.11-2004, class 1 • Frequency weighting: X-Curve in accordance with ISO 2969 • Capturing of a single reading into the internal memory for comparative measurements

Remote Measurement (optional)	<ul style="list-style-type: none"> • Querying measurement data online via the USB interface
Functions of Extended Acoustic Pack (optional)	<ul style="list-style-type: none"> • SLMeter/RTA function <ul style="list-style-type: none"> » Percentiles for wide band and 1/1 and 1/3 octave spectrum <ul style="list-style-type: none"> - 1%, 5%, 10%, 50%, 90%, 95%, 99% - Sampling: every 1.3 ms - Wide band: in 0.1 dB wide classes, based on sampling $L_{\Delta F}$ - 1/1 and 1/3 octave spectrum: in 1.0 dB wide classes, based on L_{xy} ($x = A, C$ or $Z, y = F$ or S) - Dynamic range: 140 dB » Time weighting: Impulse » Sound Pressure Levels L_{eq} » Sound Exposure Level $L_{\Delta E}$ » Event-triggered audio and data recording » Recording of linear wav-files (24 bit, 48 kHz), a new wav-file is started after each hour (max. wav-file size 512 MB) » True peak level in 1/1 and 1/3 octave resolution » Clock-Impulse Maximum Level (TaktMax) and values as specified in DIN 45645-1 • FFT function <ul style="list-style-type: none"> » High-resolution Zoom-FFT with selectable frequency ranges and resolution up to 0.4 Hz in the range of 5 Hz to 20 kHz • RT60 function <ul style="list-style-type: none"> » Reverberation time RT60 in 1/3 octave resolution

Functions of Spectral Limits Option (optional)	<ul style="list-style-type: none"> • SLMeter/RTA function <ul style="list-style-type: none"> » True peak level in 1/1 and 1/3 octave resolution • FFT function <ul style="list-style-type: none"> » High-resolution Zoom-FFT with selectable frequency ranges and resolution up to 0.4 Hz in the range of 5 Hz to 20 kHz • 1/12 octave function <ul style="list-style-type: none"> » High resolution RTA function “1/12 Oct + Tol” » Selectable 1/1, 1/3, 1/6 and 1/12 octave spectral resolution • FFT and 1/12 octave function <ul style="list-style-type: none"> » Capturing of multiple readings into the internal memory » Comparing measurement results against captures with relative or absolute curve display » Comprehensive tolerance handling » Creating tolerance masks based on captures for passed/failed measurements » Export and import of tolerance and capture files
--	---

Acoustic Analyzer	
FFT Analysis	<ul style="list-style-type: none"> • Real-time FFT with actual level, L_{eq}, L_{min}, L_{max} • Level resolution: 0.1 dB • Ranges: 7 Hz - 215 Hz, 58 Hz - 1.72 kHz, 484 Hz - 20.5 kHz with 142 frequency bins shown on display • Optional: High-resolution Zoom-FFT with selectable frequency ranges and resolution up to 0.4 Hz in the range of 5 Hz to 20 kHz • Optional: Capture and tolerance function with multiple readings for comparative measurements and passed/failed analysis
Reverberation Time RT60	<ul style="list-style-type: none"> • 1/1 octave bands results from 63 Hz - 8 kHz, based on T20 • Optional: 1/3 octave bands results from 50 Hz - 10 kHz, based on T20 • Range: 10 ms - 14 seconds • Measurement in accordance with ISO 3382 using Schroeder-method • Test signal: Impulse source or gated pink noise generated by the MR-PRO, MR2 or the included NTi Audio Test CD
Delay Time	<ul style="list-style-type: none"> • Propagation delay between electrical reference signal and acoustic signal using the internal microphone • Range: 0 ms - 1 second (0 m - 344 m) • Resolution: 0.1 ms • Test signal: NTi Audio delay test signal generated by the MR-PRO, MR2 or the included NTi Audio Test CD

Polarity	<ul style="list-style-type: none"> • Checks polarity of speakers and line signals • Positive/Negative detection of wideband and individual 1/1 octave bands through internal microphone or XLR/RCA connector • Test signal: NTi Audio polarity test signal generated by the MR-PRO, MR2 or the included NTi Audio Test CD
1/12 Octave Analysis (optional)	<ul style="list-style-type: none"> • Actual level, L_{eq}, L_{min}, L_{max} • Selectable 1/1, 1/3, 1/6 and 1/12 octave spectral resolution • Capturing of multiple readings into the internal memory • Comparing measurement results against captures with relative or absolute curve display • Comprehensive tolerance handling • Creating tolerance masks based on captures for passed/failed measurements
STI-PA Speech Intelligibility (optional)	<ul style="list-style-type: none"> • Single value STI and CIS test result in accordance with IEC 60268-16 (2003), ISO 7240-16, ISO 7240-19, DIN VDE 0828-1, DIN VDE 0833-4 • Modulation indices and individual band level results with error indicator, post-processing with recorded spectra supported • Test signal: NTi Audio STI-PA signal generated by the MR-PRO, NTi Audio TalkBox or the STI-PA Test CD

Audio Analyzer	
Level RMS	<ul style="list-style-type: none"> • True RMS detection in V, dBu, dBV and dBSPL • Range XLR/RCA input: 2 μV - 25 V (-112 dBu to +30 dBu) • Accuracy: \pm 0.5 % @ 1 kHz, • Flatness: \pm 0.1 dB @ 12 Hz to 21.3 kHz • Bandwidth (-3 dB): 5 Hz to 23.6 kHz • Resolution: 3 digits (dB scale), 5 digits (linear scale) or 6 digits (x1 scale)
Frequency	<ul style="list-style-type: none"> • Range: 9 Hz to 21.3 kHz • Resolution: 6 digits • Accuracy: \pm 0.003%
THD+N (Total Harmonic Distortion + Noise)	<ul style="list-style-type: none"> • Range: -100 dB to 0 dB (0.001 % to 100%) • Minimum level: > -90 dBu • Fundamental frequency range: 10 Hz to 21.3 kHz • Measurement bandwidth: 5 Hz to 23.6 kHz • Resolution: 3 digits (dB scale) or 4 digits (linear scale) • Residual THD+N @ XLR/RCA input: < 2 μV
Scope	Auto ranging, auto scaling
Filter	<ul style="list-style-type: none"> • Frequency weighting: A, C, Z • Highpass 100Hz, 400 Hz, 19 kHz, • Bandpass 22.4 Hz - 22.4 kHz in accordance with IEC468-4
Remote Measurement (optional)	<ul style="list-style-type: none"> • Querying measurement data online via the USB interface

Input / Output Interfaces	
Audio Inputs	<ul style="list-style-type: none"> • XLR balanced with input impedance = 200 kOhm, phantom power: +48 V switchable, automated sensor detection for NTi Audio's ASD measurement microphones and pre-amplifier MA220 • RCA unbalanced with input impedance >30 kOhm • Built-in condenser microphone for polarity testing, delay measurements and voice note recording
Audio Outputs	<ul style="list-style-type: none"> • Built-in speaker • Headphone connector 3.5 mm Minijack Stereo
USB Interface	USB mini connector for data transfer to PC, XL2 Projector and/or charging of Li-Po battery
Digital I/O	Optional 1-wire interface for control of external peripherals
TOSLink	24 bit linear PCM audio signal output (prepared for later firmware extension)
Memory	SD Card included (2 GByte), removable, storing measurement data in ASCII format, screen shots, voice notes and wav-files
Power Supply	<ul style="list-style-type: none"> • Rechargeable Li-Po battery included, type 3.7 V / 2260 mAh, typical battery lifetime > 4 hours • Dry cell batteries type AA, 4 x 1.5 V, typical battery lifetime > 4 hours • Linear external power supply 9 VDC (charges Li-Po battery during operation) • Range: 7.5 - 23.0 VDC @ minimum 6 Watt

General	
Clock	Real-time clock with lithium backup battery
Calibration	<ul style="list-style-type: none"> • Recommended calibration interval: one year • Microphone calibration with external calibrator supported • Optional calibration certificate for new instruments available
Mechanics	<ul style="list-style-type: none"> • Tripod or microphone stand mount • Wire stand mounted on rear side • Display: 160 x 160 pixels grey scale with LED back light • Dimensions (L x W x H) <ul style="list-style-type: none"> » 180 mm x 90 mm x 45 mm » 7.1" x 3.5" x 1.8" • Weight: 480 g (1 lb) including built-in Li-Po battery
Temperature	-10 °C to +50 °C (14° to 122°F)
Humidity	5% to 90% RH, non-condensing
Electromagnetic Compatibility	CE compliant: EN 61326-1 Class B, EN 55011 class B EN 61000-4-2 to -6 & -11

19. Technical Data Microphones

	M4260	M2210 - Enhanced Performance
Microphone Type	Omnidirectional, pre-polarized condenser, free field microphone	
Capsule / Transducer	1/4" permanently installed capsule	1/2" detachable capsule with 60UNS2 thread
PreAmplifier Type	-	MA220
Flatness	Class 2 (IEC61672-1) +1/-4.5 dB @ 5 Hz - 20 Hz ±1.5 dB @ 20 Hz - 4 kHz ±4.5 dB @ 4 kHz - 20 kHz	Class 1 (IEC61672-1) ±1 dB @ 5 Hz - 20 Hz ±1 dB @ 20 Hz - 4 kHz ±2 dB @ 4 kHz - 20 kHz
Frequency Range	5 Hz - 20 kHz	5 Hz - 20 kHz
Residual Noise Floor typical	29 dB(A)	19 dB(A)
Maximum SPL @ THD 3%, 1 kHz	144 dB SPL	144 dB SPL
Sensitivity typical	31.7 dBV/Pa ±3 dB (26 mV/Pa) @ 1kHz	-34 dBV/Pa ±3 dB (20 mV/Pa) @ 1kHz
Temperature Coefficient	±0.02 dB / °C @ -10°C to +50°C (14°F to 122°F)	±0.015 dB / °C @ -10°C to +50°C (14°F to 122°F)
Pressure Coefficient	not defined	-0.02 dB / kPa
Influence of Humidity	not defined	< ±0.01 dB (non-condensing)
Long Term Stability	not defined	> 250 years / dB
Temperature Range	-10°C to +50°C (14°F to 122°F)	
Humidity	5% to 90% RH, non-condensing	
Electronic Data Sheet	NTi Audio ASD in accordance with IEEE P1451.4 V1.0, Class 2, Template 27	

	M4260	M2210 - Enhanced Performance
Output Impedance	100 Ohm balanced	
Power Supply	48 VDC phantom power, 3 mA typical	
Connector	Balanced 3-pole XLR	
Dimensions	Length 150 mm (5.9"), diameter 20.5 mm (0.8")	
Weight	83 g, 2.93 oz	100 g, 3.53 oz
NTi Audio #	600 040 025	600 040 020

Typical Frequency Response

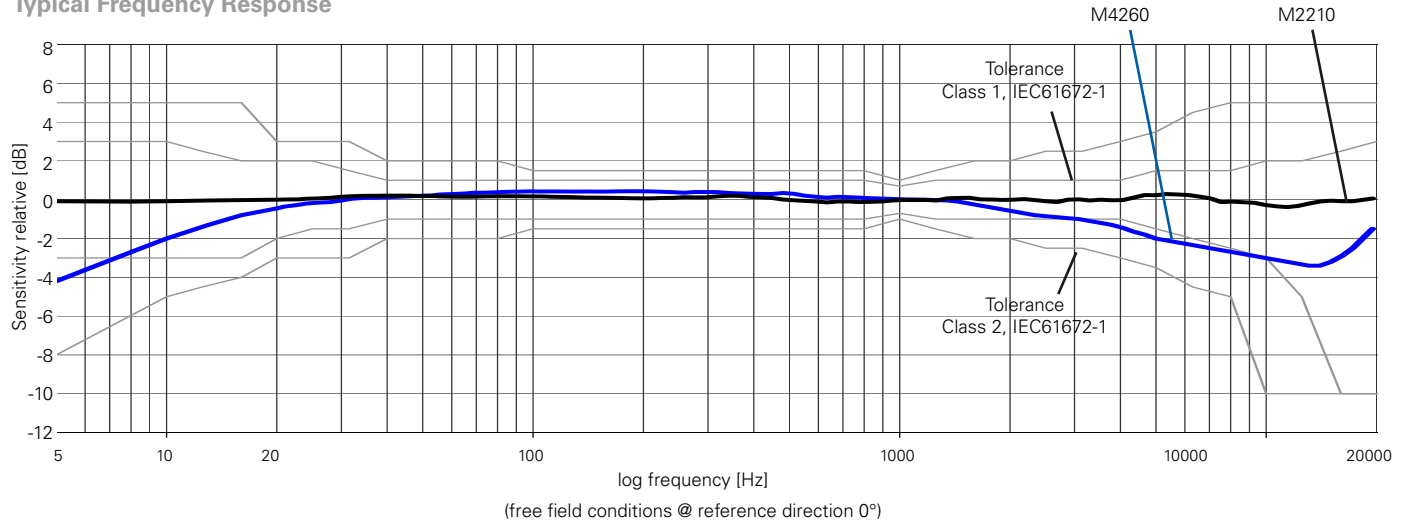

	XL2 + M4260	XL2 + M2210
Linear Measurement Range	<ul style="list-style-type: none"> • 35 dB(A) - 144 dB in accordance with IEC 60804 	<ul style="list-style-type: none"> • 28 dB(A) - 144 dB in accordance with IEC 60804

The M2215 Measurement Microphone offers the same specifications as the M2210 with the following differences:

- Residual Noise Floor typical = 30 dB(A)
- Maximum SPL @ THD 3%, 1 kHz = 155 dB SPL

Appendix

Appendix 1: Standard - Optional Features

	Standard Features	Optional
Sound Level Meter Frequency Weighting	A C Z	
Sound Level Meter Time weighting	F S EQ EQ_T PK	<ul style="list-style-type: none"> Extended Acoustic Pack: <ul style="list-style-type: none"> I Impulse E Sound Exposure Level <p>Percentile Sound Pressure Levels:</p> 1% 5% 10% 50% 90% 95% 99%
Sound Level Meter Correction	K1 K2 off	

	Standard Features	Optional
Sound Level Meter Parameter	<div style="display: flex; gap: 10px;"> Live max min Prev </div>	<ul style="list-style-type: none"> Extended Acoustic Pack: Clock-Impulse Maximum Level (Taktmaximalpegel) in accordance with DIN 45645-1: <div style="display: flex; gap: 10px; margin-top: 10px;"> T3 T3eq T5 T5eq </div> <p>Calculated levels in accordance with DIN 45645-1: LAFT5eq-LAeq LAIeq-LAeq LCeq-LAeq</p>
Sound Level Meter RTA Spectrum Analyzer		<ul style="list-style-type: none"> Extended Acoustic Pack or Spectral Limits Option: True peak level PK
Sound Level Meter Audio Recording	<ul style="list-style-type: none"> Recording of wav-files (ADPCM compression) Voice note recording 	<ul style="list-style-type: none"> Extended Acoustic Pack: Recording of wav-files (24 bit, 48 kHz)
Triggered Event Recording		<ul style="list-style-type: none"> Extended Acoustic Pack: Evt

	Standard Features	Optional
FFT Analysis Measurement Range	200 1k7 20k	<ul style="list-style-type: none"> Extended Acoustic Pack: USP with zoom function Spectral Limits: USP with zoom function
FFT + Tol Capture and Tolerance	not available	<ul style="list-style-type: none"> Spectral Limits: Capture and Tolerance functionality
RT60		<ul style="list-style-type: none"> Extended Acoustic Pack: 1/3 octave band results
1/12 Oct + Tol	function not available	<ul style="list-style-type: none"> Spectral Limits: 1/12 Oct + Tol Capture and Tolerance functionality
STI-PA	function not available	<ul style="list-style-type: none"> STI-PA Option with STI-PA functionality
Querying measurement data online via the USB interface		<ul style="list-style-type: none"> Remote Measurement Option supporting SLMeter/RTA and RMS/THD+N function

Appendix 2: Factory Default Profiles

You may start up the XL2 with individual preset application profiles.

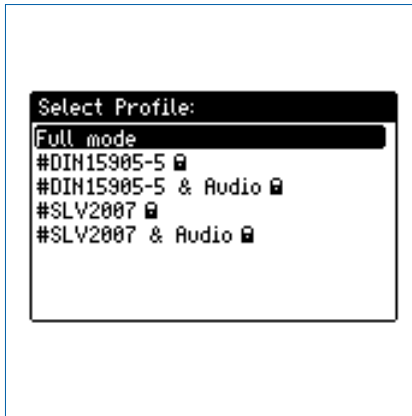

The profile **Full mode** is the default configuration with all available measurement functions enabled.

DIN15905-5 / DIN15905-5 & Audio

(Sound Level Monitoring in accordance with DIN15905-5)

The following limits apply at all areas accessible by the visitors during the measurement period of 30 minutes:

- Maximum averaged level = 99 dB
The XL2 displays this maximum level with the measurement result L_{Aeq+k1} .
- Maximum peak level $L_{Cpeak} = 135$ dB

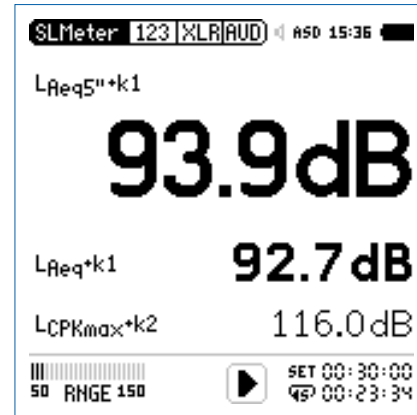

These levels are shown in the numeric result page:

$L_{Aeq5''+k1}$ Time-averaged sound pressure level L_{Aeq} with correction value k1 and a moving time window of 5 seconds.

L_{Aeq+k1} Time-averaged sound pressure level L_{Aeq} with correction value k1.



$L_{Cpeak+k2}$ C-weighted peak level L_{Cpeak} with correction value k2.

The following sound levels are displayed in the real-time analyzer page:

$L_{ZFhold3}$ For tracing of feedback frequencies. The peak hold time is set to 3 seconds.

L_{ZFlive} Actual real-time spectra.

How to Measure

- Select the page **KSET** with the rotary wheel .
- Measure the correction values k1 and k2 as described in the chapter "Correction Value KSET".
- Press the start button .
- The icon **LOG** flashes during the ongoing measurement. In the case where the profile **#DIN15905-5 & Audio** has been selected the icon **AUD** flashes, indicating the additional audio wav-file logging.
- During the measurement you can monitor the actual sound level $L_{Aeq5''+k1}$ in order to remain below the permitted limits; alternatively you may monitor the spectrum analyzer for tracing possible feedback frequencies.
- Press stop  to finish the measurement.



In accordance with DIN15905-5, all sound levels are measured, displayed and logged to the SD Card automatically. The settings are locked, which ensures that the correct parameters are measured.

The profile **#DIN15905-5 & Audio** includes the recording of **Compressed+AGC** wav-files.

Limits

This profile is configured with the following limits, which trigger the lights on the limit button and external Digital I/O Adapter. This facilitates a quick response to sound levels that exceed these limits.

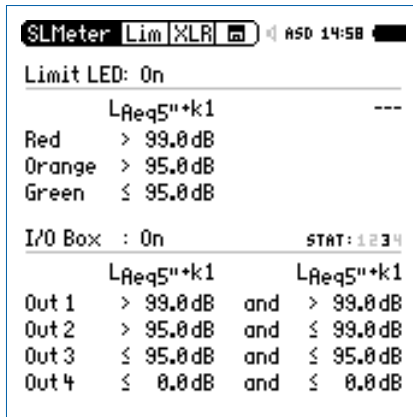

Measurement Results

You may import the log files into a report generator software based on MS Excel, providing automatically-completed live event reports with noise level charts. The report generator software is a free download on the support website at <http://my.nti-audio.com> for all registered XL2 customers.

SLV 2007 / SLV 2007 & Audio

(Sound Level Monitoring in accordance with SLV 2007)

The following limits apply at all areas accessible by the visitors during the moving measurement period window of 60 minutes during the live event:

- Maximum averaged level

Type of live event	Max. level	Description
1	93 dB	Live events, which do not comply to requirements for live events of type 2 or 3
2	96 dB	- Sound level monitoring - Level warning to visitors - Hearing protection distributed
3	100 dB	- Sound level recording - Results to store for 30 days - Level warning to visitors - Hearing protection distributed - Chill out zone < 85 dB(A)

The XL2 displays this maximum level with the measurement result $L_{Aeq60'+k1}$.

- Maximum peak level $L_{AFmax} = 125$ dB

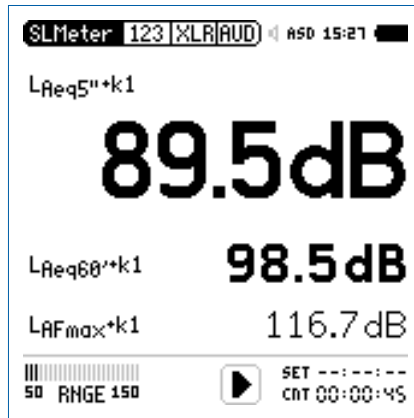



These levels are shown in the numeric result page:

- LAeq5''+k1** Time-averaged sound pressure level L_{Aeq} with correction value $k1$ and a moving time window of 5 seconds.
- LAeq60''+k1** Time-averaged sound pressure level L_{Aeq} with correction value $k1$ and a moving time window of 60 minutes.
- LAFmax+k1** Maximum sound pressure level L_{AFmax} with correction value $k1$.

The following sound levels are displayed in the real-time analyzer page:

- LZFhold3** For tracing of feedback frequencies. The peak hold time is set to 3 seconds.
- LZFfive** Actual real-time spectra.

How to Measure

- Select the page KSET with the rotary wheel .
- Measure the correction value $k1$ as described in the chapter "Correction Value KSET". ($k2$ is not required for SLV2007)
- Press the start button .
- The icon **LOG** flashes during the ongoing measurement. In the case where the profile **#SLV2007 & Audio** has been selected the icon **AUD** flashes, indicating the additional audio wav-file logging.
- During the measurement you can monitor the actual sound level $L_{Aeq5''+k1}$ in order to remain below the permitted limits; alternatively you may monitor the spectrum analyzer for tracing possible feedback frequencies.
- Press stop  to finish the measurement.



In accordance with SLV 2007, all sound levels are measured, displayed and logged to SD Card automatically. The settings are locked, which ensures that the correct parameters are measured.

The profile **#SLV2007 & Audio** includes the recording of **Compressed+AGC** wav-files.

Limits

This profile is configured with the following limits, which trigger the lights on the limit button and external Digital I/O Adapter. This facilitates a quick response to sound levels that exceed these limits.

```

SLMeter Lim XLR [ ] 150 15:28
-----
Limit LED: On
          LAeq5" +k1      ---
Red      > 100.0dB
Orange   >  96.0dB
Green    ≤  96.0dB
-----
I/O Box  : On           STAT: 1234
          LAeq5" +k1      LAeq5" +k1
Out 1    > 100.0dB   and > 100.0dB
Out 2    >  96.0dB   and ≤ 100.0dB
Out 3    ≤  96.0dB   and ≤  96.0dB
Out 4    ≤   0.0dB   and ≤   0.0dB
    
```

Measurement Results

You may import the log files into a report generator software based on MS Excel, providing automatically-completed live event reports with noise level charts. The report generator software is a free download on the support website at <http://my.nti-audio.com> for all registered XL2 customers.

Appendix 3: Description Sound Levels

A A-Frequency Weighting Filter in accordance with IEC 61672

Applicable for most common sound pressure level measurements, compensating for human hearing perception at lower sound pressure levels.

C C-Frequency Weighting Filter in accordance with IEC 61672

Applicable for very high sound pressure levels, compensating for human hearing perception at high sound pressure levels; typically used for measurements of peak values, e.g., L_{Cpeak}

Capt Capture

This selection offers the reference curve, which has been previously stored with **Capture** in the spectrum analyzer of the SLMeter function.

Application example:

- Comparing the performance of the left and right speakers in a live event sound setup.

E Sound Exposure Level

The sound exposure level L_{AE} is the L_{Aeq} normalized to 1 second. The sound exposure level is measured to compare noise events with different time durations. The L_{AE} reports the amount of noise from an event such as an individual aircraft fly-over.

$$L_{AE} = L_{Aeq} + 10 \times \log(\text{time in seconds})$$

EQ Time-Average Sound Level or Equivalent Continuous Sound Level in accordance with IEC 61672

EQ-T Moving Time-Average Sound Level or Moving Equivalent Continuous Sound Level

with selectable time intervals of 5 seconds, 10 minutes, 15 minutes or 60 minutes. The moving time-average sound level is an L_{eq} based on a moving time window.

Sample:

10h 00min 00sec Start of XL2 measurement

10h 00min 05sec $L_{eq5''} = L_{eq}$ of this 5 seconds

10h 00min 06sec Leq5" = Leq of the time window from 10h 00min 01sec to 10h 00min 06sec

10h 00min 07sec Leq5" = Leq of the time window from 10h 00min 02sec to 10h 00min 07sec

Application example:

- Display the moving Leq over 5 seconds in accordance with DIN15905
- Measure the moving Leq over 60 minutes in accordance with SLV2007

F Fast Time Weighting

Time constant $t = 125$ ms; the time weighting is an exponential function of time, which defines how changes of the instantaneous sound pressure level are averaged for useful sound pressure level results. The measurement results are shown accurately for sound sources with a minimum length of 0.5 seconds. Fast time weighting is typically used for common sound level measurements.

Hold

Holding Maximum Level

For tracing of feedback frequencies in the RTA page. The hold time can be set to 3, 5 or 10 seconds.

I

Impulse Time Weighting

Time constant increase $t = 35$ ms; time constant decrease $t = 1500$ ms; the time weighting is an exponential function of time, which defines how changes of the instantaneous sound pressure level are averaged for useful sound pressure level results. The measurement results are shown accurately for sound sources with a minimum length of 0.1 seconds. Impulse time weighting is used for impulsive sound sources.

K1

Correction Value k1

Applies to RMS based values (L_{AF} , L_{Aeq} , ...). The correction value k1 is measured or manually set in the page **KSET** of the sound level meter function.

K2

Correction Value k2

Applies to time-weighting setting PK (= peak). The correction value k2 is measured or manually set in the page **KSET** of the sound level meter function.

**Parameter live**

Actual current sound pressure level.

**Parameter max**

Maximum sound level of the measurement cycle.

**Parameter min**

Minimum sound level of the measurement cycle.

**Correction Value off**

No correction value, default setting.

**Peak Level**

Application example:

Measure L_{Cpeak} in accordance with DIN15905

The RTA spectrum analyzer measures the true peak level with the optional Extended Acoustic Pack. The peak hold time can be set to 0, 1 or 5 seconds.

**Previous Leq**

Applicable for timer mode Repeat or Repeat Synchronized; displays the time-averaged sound level Leq of the last measurement cycle.

**Percentile Sound Level - Level Statistics**

The statistical distribution of sound pressure levels is commonly used for environmental noise analysis, such as road traffic or community noise assessments. $L_{AFxx\%}$ is the noise level exceeded during xx% of the measurement period; e.g., $L_{AF90\%}$ is the noise level exceeded during 90% of the measurement period. The XL2 offers percentile statistics for wide band, 1/1 and 1/3 octave spectrum:

- 1%, 5%, 10%, 50%, 90%, 95%, 99%
- Sampling: every 1.3 ms
- Wide band: in 0.1 dB wide classes, based on sampling LAF
- 1/1 and 1/3 octave spectrum: in 1.0 dB wide classes, based on L_{xy} (x= A, C or Z, y= F or S)
- Dynamic range: 140 dB

**Slow Time Weighting**

Time constant $t = 1$ second; the time-weighting is an exponential function of time, which defines how changes of the instantaneous sound pressure level are averaged for useful sound level results.

T3

Parameter T3

Clock-Impulse Maximum Level (Taktmaximalpegel) L_{AFT3} in accordance with DIN 45645-1. Maximum sound pressure level measured with frequency weighting A and time weighting F within a time interval of 3 seconds.

T3eq

Parameter T3 equivalent

Time-average Clock-Impulse Maximum Level (Taktmaximalpegel) L_{AFT3eq} in accordance with DIN 45645-1.

T5

Parameter T5

Clock-Impulse Maximum Level (Taktmaximalpegel) L_{AFT5} in accordance with DIN 45645-1. Maximum sound pressure level measured with frequency weighting A and time weighting F within a time interval of 5 seconds.

T5eq

Parameter T5 equivalent

Time-average Clock-Impulse Maximum Level (Taktmaximalpegel) L_{AFT5eq} in accordance with DIN 45645-1.

X⁻¹

Inverted X-Curve

In the film and recording industry an X curve is also known as a wide-range curve, e.g., used for cinema installations; conforms to ISO 2969.

Z

Z-frequency weighting in accordance with IEC 61672 (= flat frequency response, no filter)

Overall sound pressure level, all sound signal components are included; required for special applications.

Appendix 4: Common Sound Levels

Display	Application	Setting
L _{AE}	<p>Sound Exposure Level</p> <p>The sound exposure level L_{AE} is the L_{Aeq} normalized to 1 second. The sound exposure level is measured to compare noise events with different time durations. The L_{AE} reports the amount of noise from an event such as an individual aircraft fly-over.</p> <p>$L_{AE} = L_{Aeq} + 10 \times \log(\text{time in seconds})$</p>	A -> E
L _{AF}	<p>Actual Sound Pressure Level</p> <p>SPL with A frequency weighting and F time weighting, compensating for human hearing perception at lower sound pressure levels; applicable at levels lower than 100 dB.</p>	A -> F -> live -> off
L _{AFmin}	<p>Minimum Sound Pressure Level</p> <p>Measures the minimum environmental noise level during the measurement period.</p>	A -> F -> min
L _{Aeq}	<p>Time-Average Sound Level or Equivalent Continuous Sound Level</p> <p>Averaged sound level over time with A frequency weighting.</p>	A -> EQ -> off

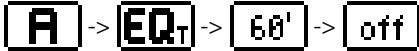
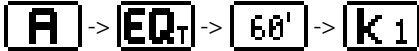
$L_{Aeq} + k1$	<p>Time-Average Sound Level with Correction Value</p> <p>The actual measurement position often differs to the loudest position of the live event. Thus the correction value k1 is the correction value of L_{Aeq} between the loudest position and the actual measurement position, measured using pink noise. The correction value k1 is measured or manually set in the page KSET of the sound level meter function.</p>	
L_{Aeqxx}	<p>Moving Time-Average Sound Level</p> <p>Measurement of the moving sound level over time L_{eq} with A-weighting frequency and F-weighting time responses; the parameter xx is user-defined from the available settings:</p> <ul style="list-style-type: none"> • 5 seconds for live sound monitoring • 10 minutes (in accordance with the French standard) • 15 minutes (in accordance with the British standard) • 60 minutes (in accordance with SLV 2007) 	
$L_{Aeq60'} + k1$	<p>Moving Time-Average Sound Level with Correction Value k1</p> <p>The actual measurement position often differs to the loudest position of the live event. Thus the correction value k1 is the correction value of $L_{Aeq60'M}$ between the loudest position and the actual measurement position, measured using pink noise. The correction value k1 is measured or manually set in the page KSET of the sound level meter function.</p> <p>Application: Measurements in accordance with SLV 2007</p>	

$L_{C_{peak}} + k_2$ **Peak Sound Pressure Level with Correction Value**

The actual measurement position often differs to the loudest position of the live event. Thus the correction value k_2 is the correction value of $L_{C_{peak}}$ between the loudest position and the actual measurement position, measured using pink noise. The correction value k_2 is measured or manually set in the page KSET of the sound level meter function.



LAF_{xx}%

Percentile Sound Level

The statistical distribution of sound pressure levels is commonly used for environmental noise analysis, such as road traffic or community noise assessments. LAF_{xx}% is the noise level exceeded during xx% of the measurement period; e.g., LAF₉₀% is the noise level exceeded during 90% of the measurement period. The XL2 offers percentile statistics for wide band, 1/1 and 1/3 octave spectrum:

- 1%, 5%, 10%, 50%, 90%, 95%, 99%
- Sampling: every 1.3 ms
- Wide band: in 0.1 dB wide classes, based on sampling LAF
- 1/1 and 1/3 octave spectrum: in 1.0 dB wide classes, based on L_{xy} (x= A, C or Z, y= F or S)
- Dynamic range: 140 dB

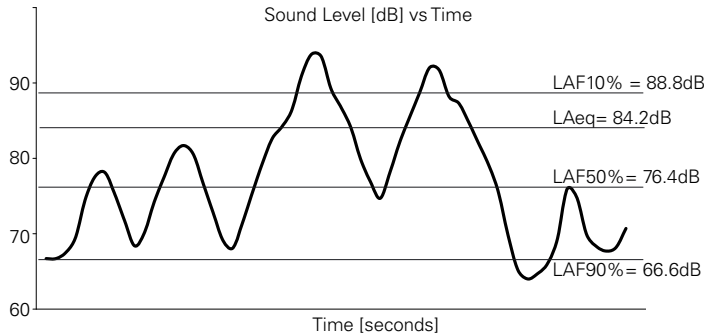

MORE -> 90% -> off

L_{EX}**Noise Exposure Level L_{EX}**

The Noise at Work Directive 2003/10/EC lays down minimum requirements for the protection of workers from risks to their health and safety arising or likely to arise from exposure to noise and in particular the risk to hearing.

- Steady noise $L_{EX,8h} = L_{Aeq}$: (applies to L_{AS} , deviation < 5 dB)
 L_{Aeq} measured over a short time equals $L_{EX,8h}$; the following formula applies for a measurement period < 8 hours: $L_{EX,8h} = L_{Aeq} + 10 \times \log (T / 8 \text{ hours})$
- Steady noise with stepped level variations:
 Measure L_{Aeq} at the different levels and enter the data with the corresponding exposure time in the NTi Audio noise exposure level post-processing form; the $L_{EX,8h}$ will be calculated and displayed
- Varying noise levels:
 $L_{EX,8h} = L_{Aeq}$ measured for 8 hours

The exposure limit values and respective actions are:

	L _{EX} , 8h	L _{Cpeak}	Action
Lower limit value	80 dB(A)	135 dB	The employer shall make individual hearing protectors available to workers
Upper limit value	85 dB(A)	137 dB	Hearing protectors shall be used
Exposure limit	87 dB(A)	140 dB	The attenuation characteristics of the hearing protectors worn must adequately reduce the levels below this limit



